



Level 1

ELECTRIC

HYDRAULICS

PNEUMATICS

ELECTRICAL SAFETY

- Physiological effects of electricity
- Most of us have experienced some form of electric "shock," where electricity causes our body to experience pain or trauma. If we are fortunate, the extent of that experience is limited to tingles or jolts of pain from static electricity buildup discharging through our bodies. When we are working around electric circuits capable of delivering high power to loads, electric shock becomes a much more serious issue, and pain is the least significant result of shock.

CURRENT FLOW FROM THE SOURCE TO THE LOAD

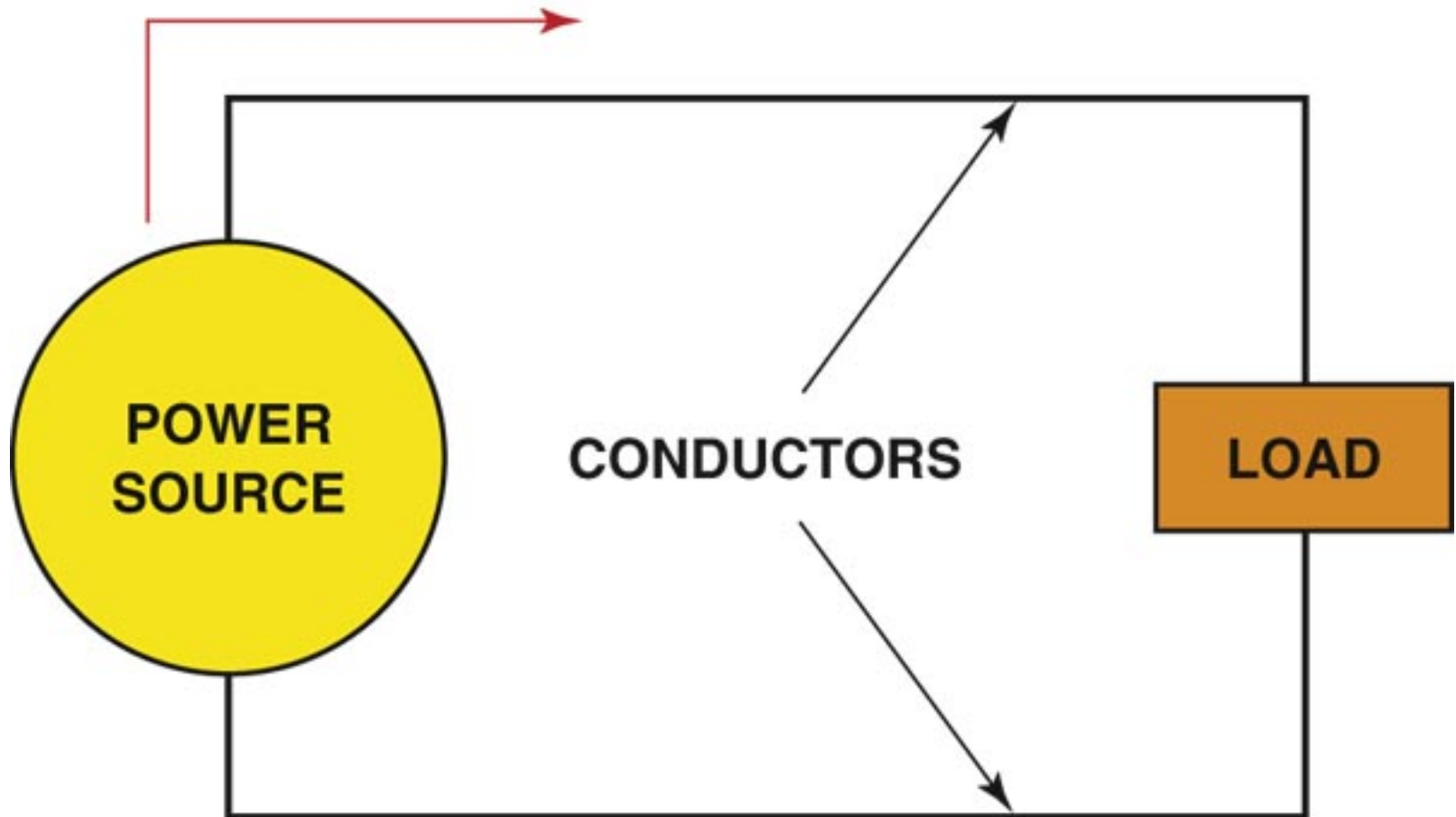

CURRENT FLOW FROM THE LOAD BACK TO THE SOURCE

Shock current path

As we've already learned, electricity requires a complete path (circuit) to continuously flow. This is why the shock received from static electricity is only a momentary jolt: the flow of electrons is necessarily brief when static charges are equalized between two objects. Shocks of self-limited duration like this are rarely hazardous.

THIS PERSON IS NOW PART OF THE CIRCUIT AND THE CIRCUIT CURRENT WILL FLOW THROUGH THE BODY

CURRENT FLOW FROM THE SOURCE TO THE LOAD

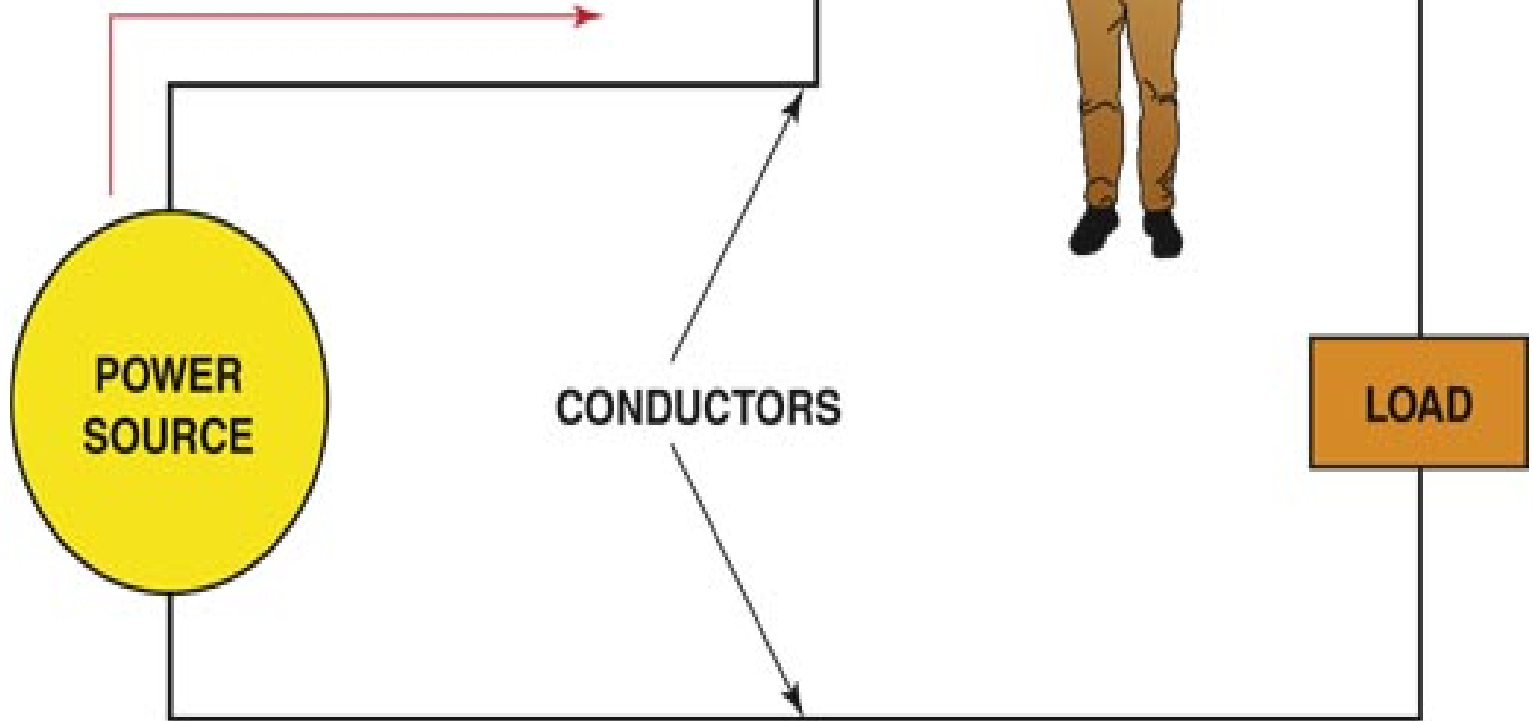

CURRENT FLOW FROM THE LOAD BACK TO THE SOURCE

Lockout / Tagout (LOTO)

- *Refers to specific practices and procedures to safeguard employees from the unexpected energization or startup of machinery and equipment, or the release of hazardous energy during service or maintenance activities.*



No. 1457E410KA



Designed for
Lockout/Tagout



08/2011



N.A.A.R.S.O.



CAUTION



**THIS MACHINE MUST BE
LOCKED OUT BEFORE
DOING MAINTENANCE.**

**ALL SOURCES OF ENERGY MUST
BE LOCKED IN THE "OFF" OR
"SAFE" POSITION. DE-ENERGIZE OR
BLOCK ALL STORED ENERGY.**



OSHA

- [Section 5\(a\)\(1\)](#) of the OSH Act, often referred to as the General Duty Clause, requires employers to "furnish to each of his employees employment and a place of employment which are free from recognized hazards that are causing or are likely to cause death or serious physical harm to his employees".
- [Section 5\(a\)\(2\)](#) requires employers to "comply with occupational safety and health standards promulgated under this Act".

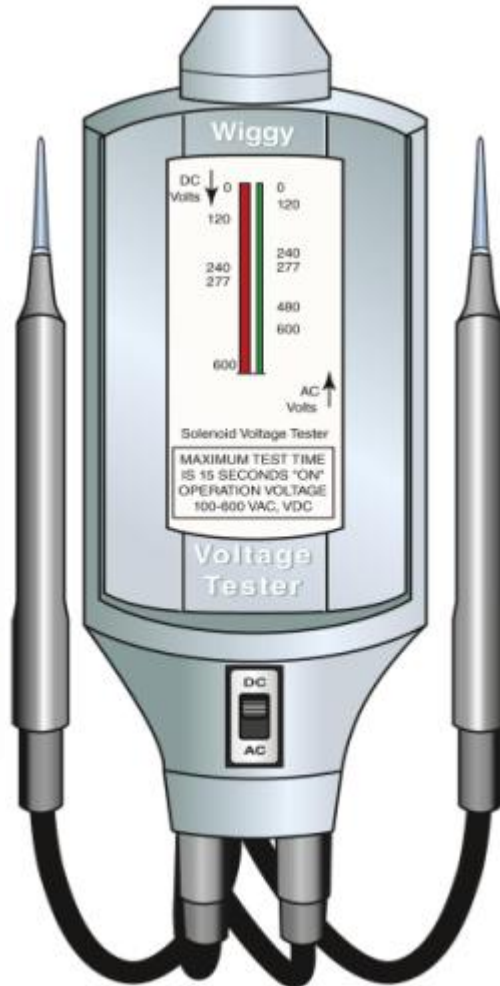

(B)

Service Drop

The lines that bring power from the telephone pole to your house are called service drops. They're connected to the main electrical panel of your house by the power company and they're also maintained by them.

Service Entrance

The service entrance comprises all the equipment through which the utility brings electricity into your home. This includes the mast on your roof where the utility makes the wire connections, the electric meter and an external disconnect switch if one is required.

Measuring Electricity

Voltage

is the pressure that pushes electricity across a conductor. In the United States, most utilities serve residences with two lines at 125 volts each, which can provide up to 250 volts if used together. Common terminology may call this 110 volts or 120 volts.

Amperes

are how much electricity is flowing. The more amperes that flow, the thicker the wire needed to carry it. Wire is measured by gauge and National Electric Code specifies wire thickness for specific amounts of current.

Service Panel

The service panel goes by many names, including circuit breaker box, breaker box, circuit panel and fuse box. The main service panel holds the main circuit breaker and the circuit breakers for branch circuits. It may also serve other panels, called sub panels, that also distribute power to branch circuits.

Branch Circuits

A branch circuit begins at a circuit breaker in a service panel. The branch circuit may supply a single outlet, a permanently wired appliance or multiple outlets. The most common branch circuit has all the outlets for a room including the lighting outlet.

Outlets

An outlet refers to any point where electricity becomes accessible to the homeowner. Receptacles are often referred to as outlets. Other outlets include light fixtures for recessed and non-recessed lighting, wall sconces and dryer and range receptacles. Any light fixture is considered a single outlet even though it may have multiple light bulbs.

Sheathed Cable

Ninety five percent of all homes in the United States have sheathed cable wiring. This is often referred to by the trade name ROMEX[®], a company that manufactures one brand of sheathed cable.

A plastic or metal sheath contains two or more current-carrying conductors in addition to a ground wire. Number and letter codes on the cable define the wires inside and the application.

Hot Wire

The hot wire in a circuit carries current from the service panel to the outlet. If a circuit is controlled by a switch, the switch must be on the hot wire. The hot wire in house wiring is usually black or any other color wire except white, gray or green.

Grounded Conductor

The grounded conductor is often mistakenly called the neutral wire. Every 125-volt branch circuit requires a grounded conductor. The grounded conductor carries current back to the service panel after it has been used by an appliance. At the main service panel, the grounded conductor connects to earth ground. Grounded conductors must be white or natural gray.

Ground Wires

Don't confuse ground wires with grounded conductors. A ground wire attaches to anything that might conduct electricity but is not supposed to. The sheet metal of an electric dryer is a good example. If the hot wire accidentally came loose and touched the metal exterior, someone touching the dryer could receive a shock. A ground wire provides a safe path to ground in the event the hot wire touches something it should not. Ground wires are bare or have green insulation.

Neutral Wire

A true neutral wire only exists on the line that runs between the electric utility transformer and the service entrance or on branch circuits that use a combination of 125 volts and 250 volts. The neutral wire carries the difference between the two hot wires in these circuits.

Circuit Breaker

This switching mechanism can be turned on or off manually to cut power to the circuit it controls and it trips automatically to turn off power when it detects excessive current on its circuit. Since circuit breakers can only protect a circuit they're rated for, a 15A (Amp) circuit breaker will only prevent a 15A circuit from burning out.

Section 525-16 states that overcurrent protection of equipment and conductors shall be provided in accordance with Article 240. Tents and concession stands that are fed by circuit to which cords or cables are connected must have overcurrent protection that protects the cord or cable as well as equipment in the tent or concession stand. There must be overcurrent protection in the tent or concession. Section 525-30 entitled "Type and Location," states that "Each ride and concession shall be provided with a fused disconnect switch or circuit breaker located within sight and within 6 ft of the operator's station."

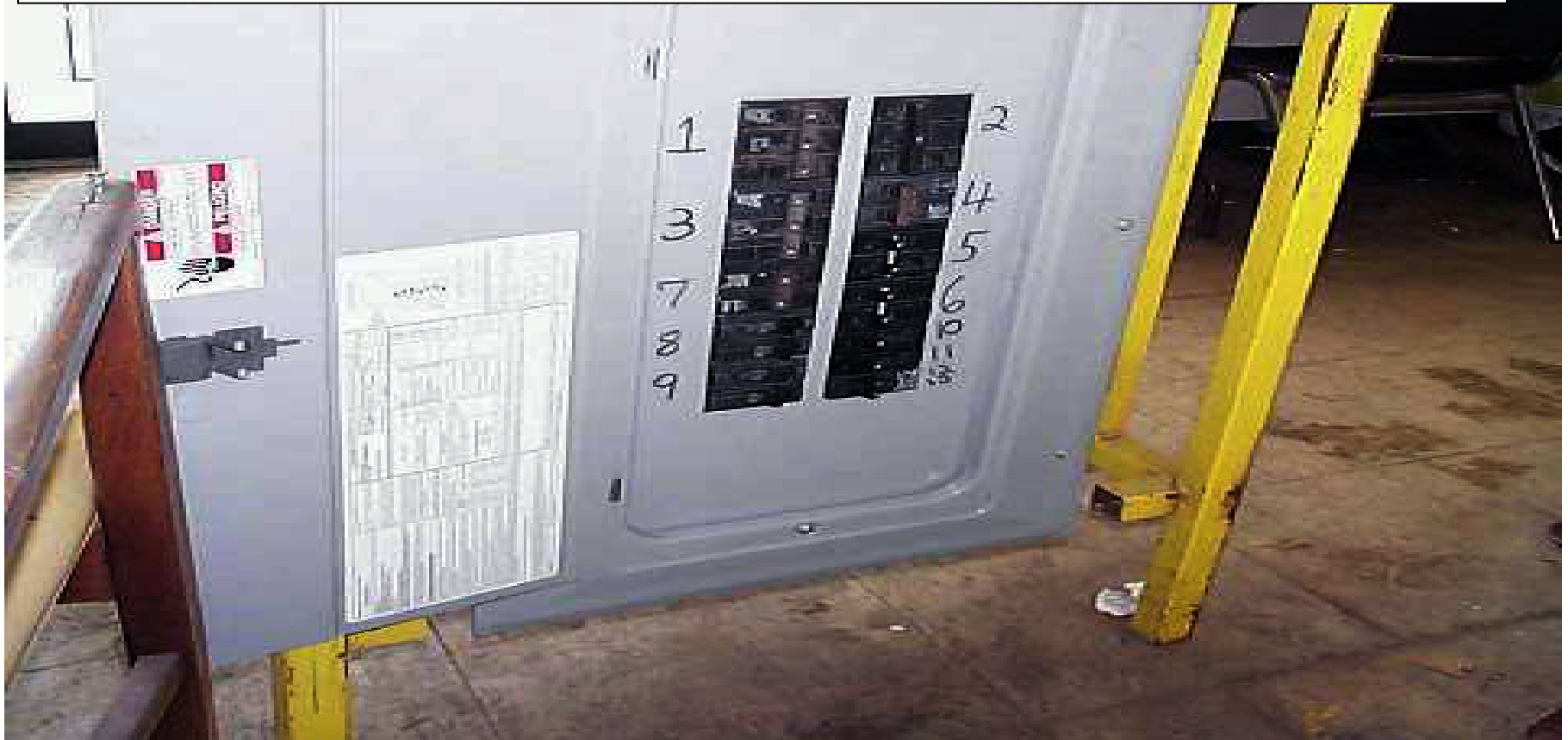

Branch Circuit

The electrical wires between the circuit breakers in your main electrical panel and the outlets in your walls are called branch circuits. These outlets also include the lighting receptacles in your ceiling and your major appliance connections.

PLUG

A male electrical connector that's attached to the insulated wires of an electrical device is called a plug. When this male connector is inserted into a wall receptacle's female connector, electricity flows to the device.

Receptacle

A wall plate with female connectors that's tied in to the branch circuit in your home is called a receptacle. When a plug is inserted into this receptacle, electricity flows from the branch circuit to the device the plug connects to.

Line

The wires that bring electricity to a device (incoming) are line wires and the terminals these wires connect to are line terminals. Line voltage is the electrical potential across these wires.

Load

The wires that take electricity from a device (outgoing) are load wires and the terminals these wires connect to are load terminals. A load is also the power consumed by a device when it converts electrical energy to something else (i.e. light, sound, etc.).

Parallel Circuit

A circuit where electrical current divides and follows several paths is a parallel circuit. Since the voltage (electrical potential) across all the loads in this circuit is the same, you can remove a load (i.e. light bulb) without affecting the others.

Series Circuit

A circuit where electrical current follows one path is a series circuit. Since this current passes through each load to get to the next, if you remove any of the loads you'll create a gap in the circuit and current flow will stop (an open circuit). Christmas tree lights are often wired in series and that's why all the lights go off when one burns out.

Common Electrical Wiring Color Code

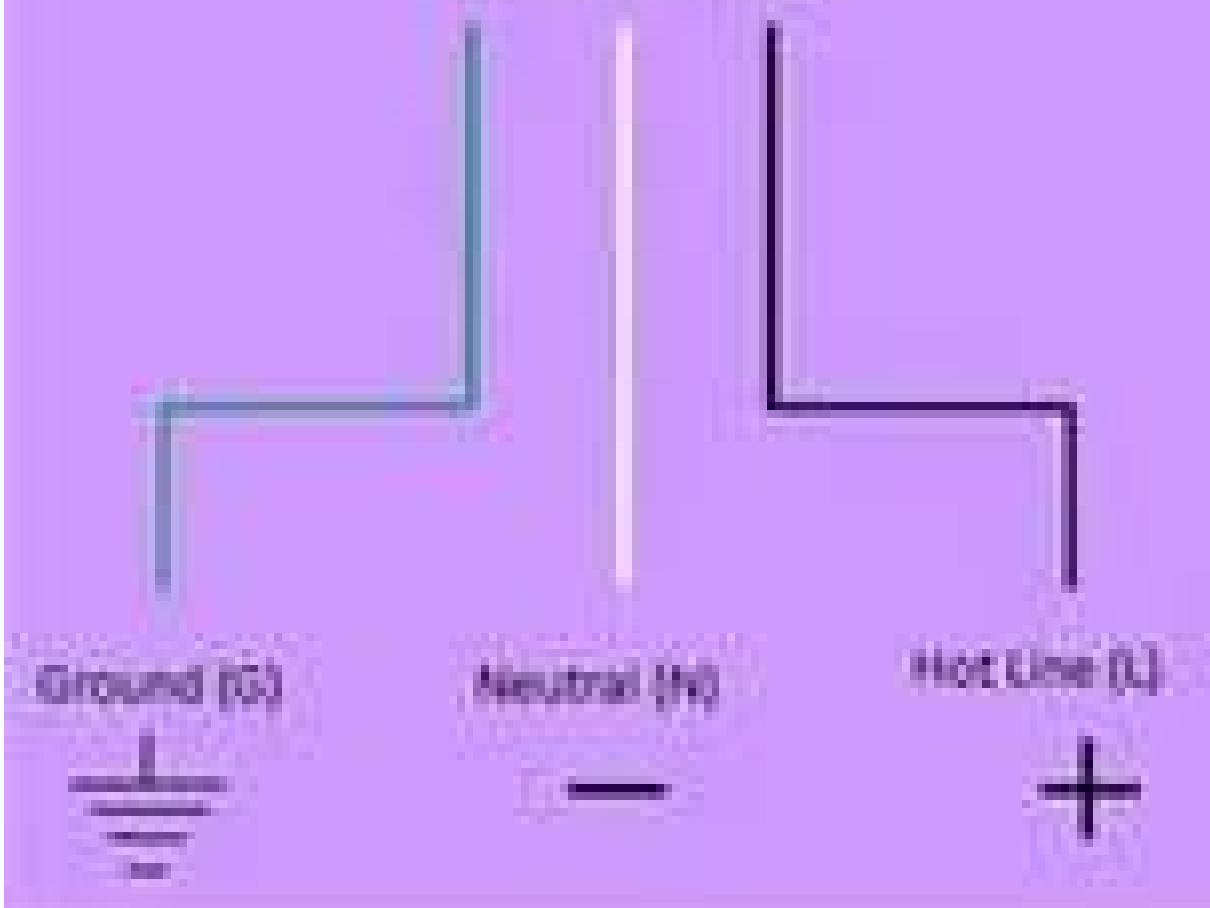

A)

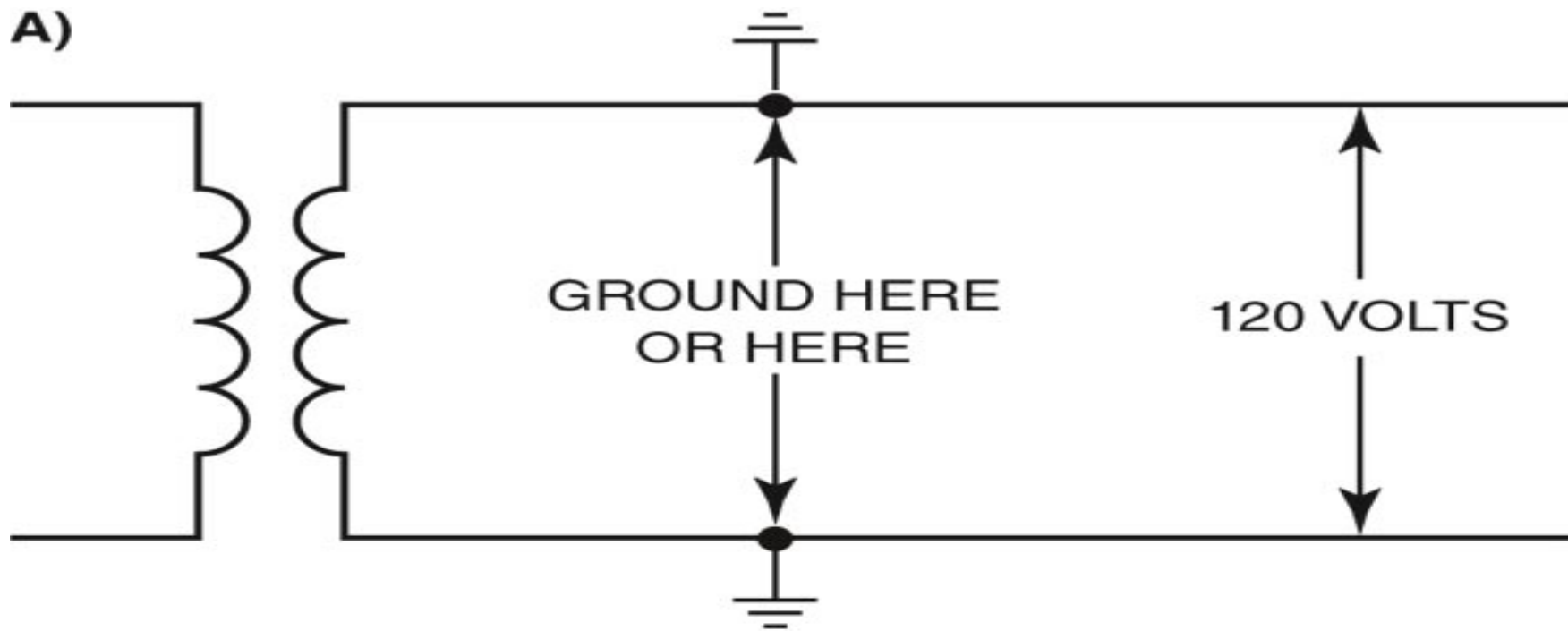

B)

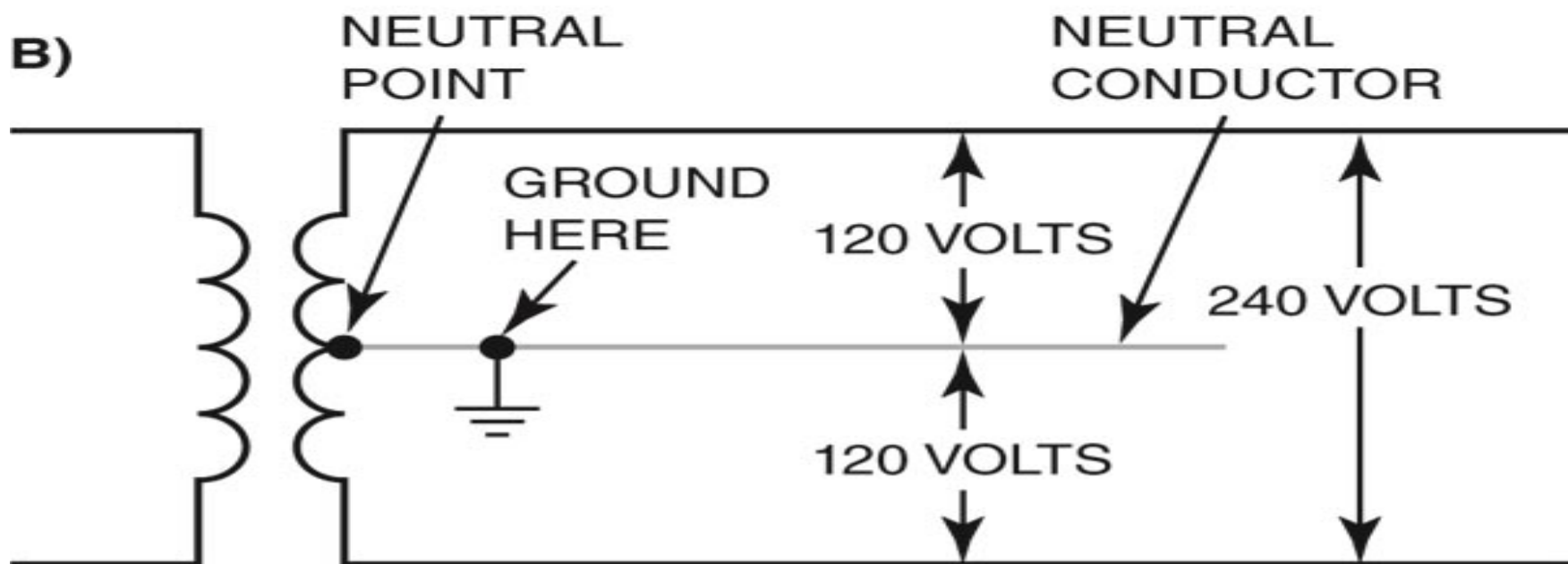

120 volts vs 220 volts usa.

3 phase

3-WIRE HOOK UP

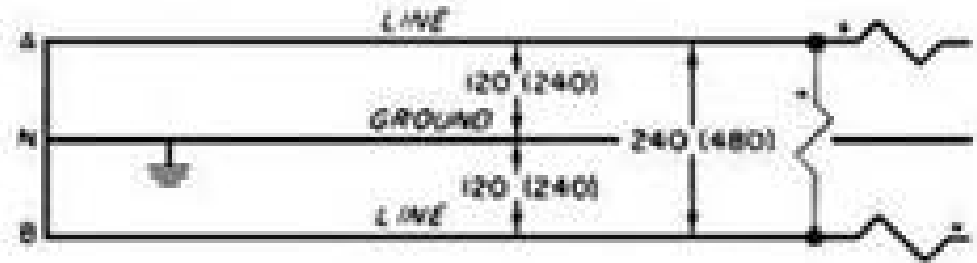
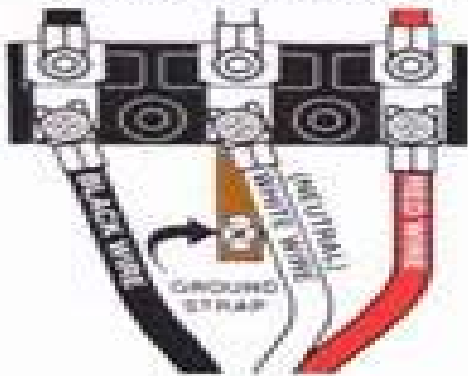

THREE WIRE

3-WIRE HOOK UP



4-WIRE HOOK UP



WEMA 10 50A 10AMP-125/250VOLT



WEMA 14 50 10AMP-125/250VOLT

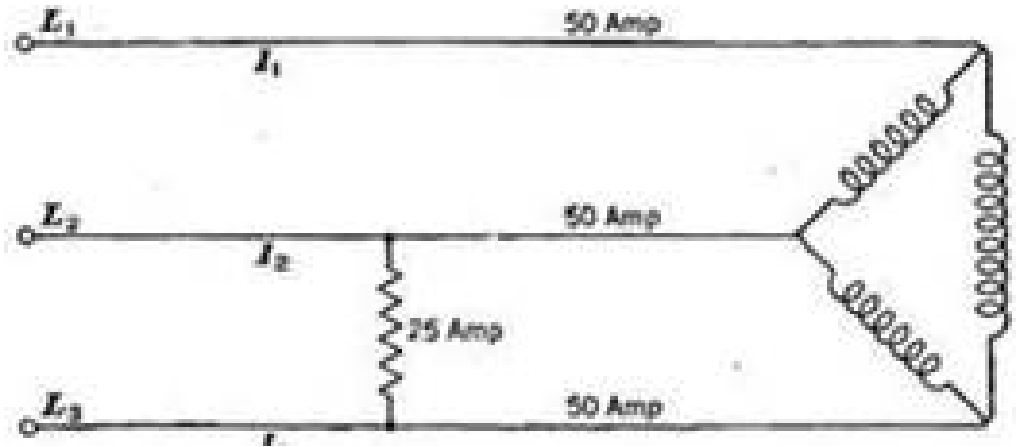

Us vs euro wiring

»

120

240

3 phase

- Neutral **COPPER/BARE**
- Ground **GREEN**
- Hot **BLACK**
- Hot **RED**
- Hot **BLUE**

USA

- Neutral **BLUE**
- Ground **GREEN/YELLOW**
- Hot **BROWN**
- Hot **BLACK**
- Hot **RED**

EURO

	L1	L2	L3	Neutral	Ground / Protective Earth
United States (American Wire Code)	Black	Red	Blue	Gray or white	Green, Green/yellow striped or a bare copper wire
United States (IEEE Std 800-2013)	Brown	Orange (Delta) or Violet (Wye)	Yellow	Gray or white	Green
Canada (mandatory) [5]	Red	Black	Blue	white	Green (or bare copper)
Canada (Voluntary Standard Installation) [6]	Orange	Brown	Yellow	white	Green
European Union, and all countries who use European CENELEC standards: April 2004 (IEC 60446), Hong Kong from July 2007	Brown	Black	Grey	Blue	Green / yellow striped 4
Older European (IEC 60446, varies by country) ⁷	Black or brown	Black or brown	Black or brown	Blue	Green/yellow striped 5
UK until April 2006, Hong Kong until April 2009, South Africa, Malaysia	Red	Yellow	Blue	Black	Green/yellow striped (green on installations approx. before 1970)
Pakistan	Red	Yellow	Blue	Black	Green
India	Red	Yellow	Blue	Black	Green
Australia and New Zealand (per AS/NZS 3000:2000 Section 3.8.1)	Red 3	white writes [prev. yellow]	Black	Black	Green/yellow striped (green on very old installations)
People's Republic of China (per GB 50203-2002 Section 15.2.2)	Yellow	Green	Red		

60 cycle vs 50 cycles

120 and 220 Volt; 60 Hertz (USA)

230 Volt; 50 Hertz (Europe & Asia)

What is the difference between 50 and 60 Hertz for an electric cycle?

The difference between 50 and 60Hz is, well, 60Hz is 20% higher in frequency.

For a generator or motor (in simple terms) it means 1500/3000 RPM or 1800/3600 RPM (for 60Hz).

electricity our North American appliances use is delivered at 120VAC (volts alternating current) 60 Hz (60 cycles/second). When the electric current flows it rises from 0 volts to 120 volts back to 0 volts and then it falls to negative 120 volts and rises back to 0 volts. This rise and fall completes one cycle (1 Hz) and is called a "sine wave."

Cycles: 50 Hz vs. 60 Hz

North American 120 volt electricity is generated at 60 Hz Alternating Current (AC). Most foreign 220–240 volt electricity is generated at 50 Hz Alternating Current (AC). This difference in cycles may cause the motor in your 60 Hz North American appliance to operate slightly slower when used on 50 Hz foreign electricity.

SINGLE-CONDUCTOR WIRES

Solid-core wire



Stranded wire



MULTICONDUCTOR CABLES

Type NM (nonmetallic sheathed) cable "12-2"

For interior circuits; routed behind walls, ceilings, floors



Type NM (nonmetallic sheathed) cable "14-3"

For interior circuits; contains two hot wires

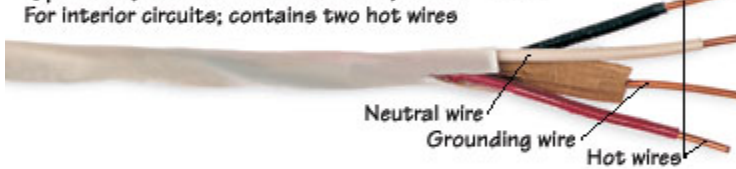

Large appliance cable

For dedicated 120/140-volt circuits; stranded wires are bendable--but barely



Type MC armored cable

For interior circuits only



3/0 Gauge		200 Amps Service entrance
1/0 Gauge		150 Amps Service entrance and feeder wire
3 Gauge		100 Amps Service entrance and feeder wire
6 Gauge		55 Amps Feeder and large appliance wire
8 Gauge		40 Amps Feeder and large appliance wire
10 Gauge		30 Amps Dryers, appliances, and air conditioning
12 Gauge		20 Amps Appliance, laundry and bathroom circuits
14 Gauge		15 Amps General lighting and receptacle circuits



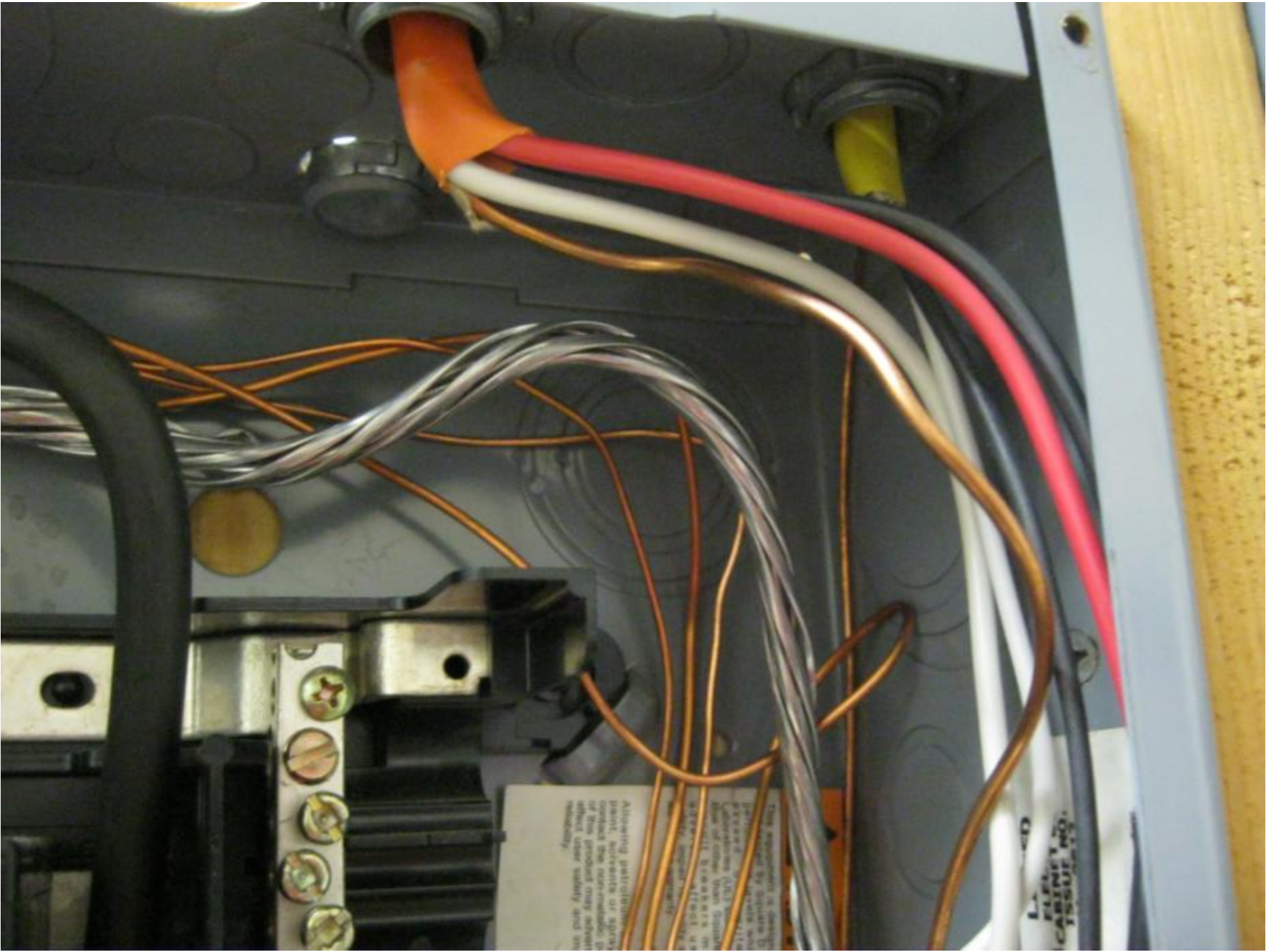

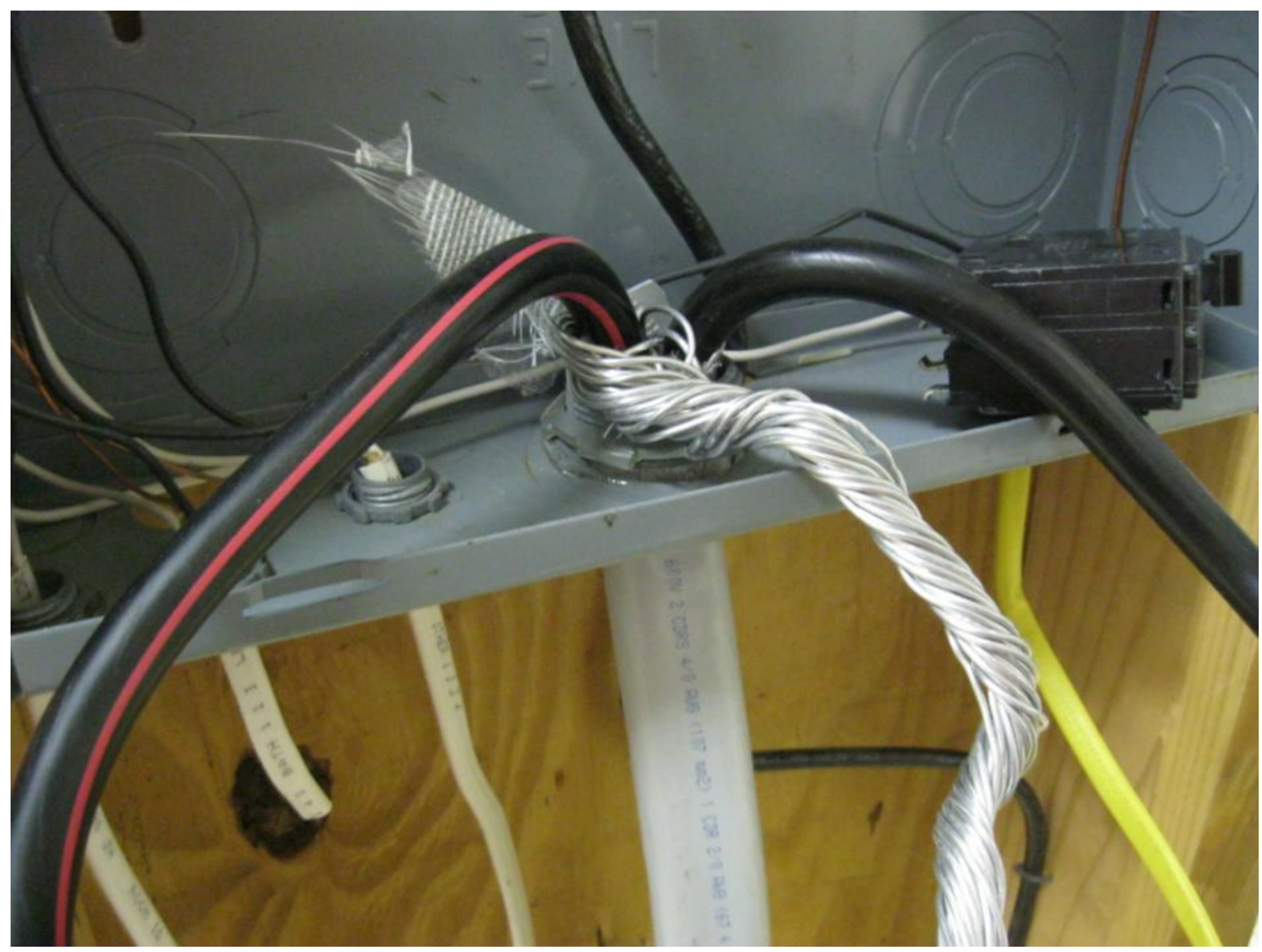

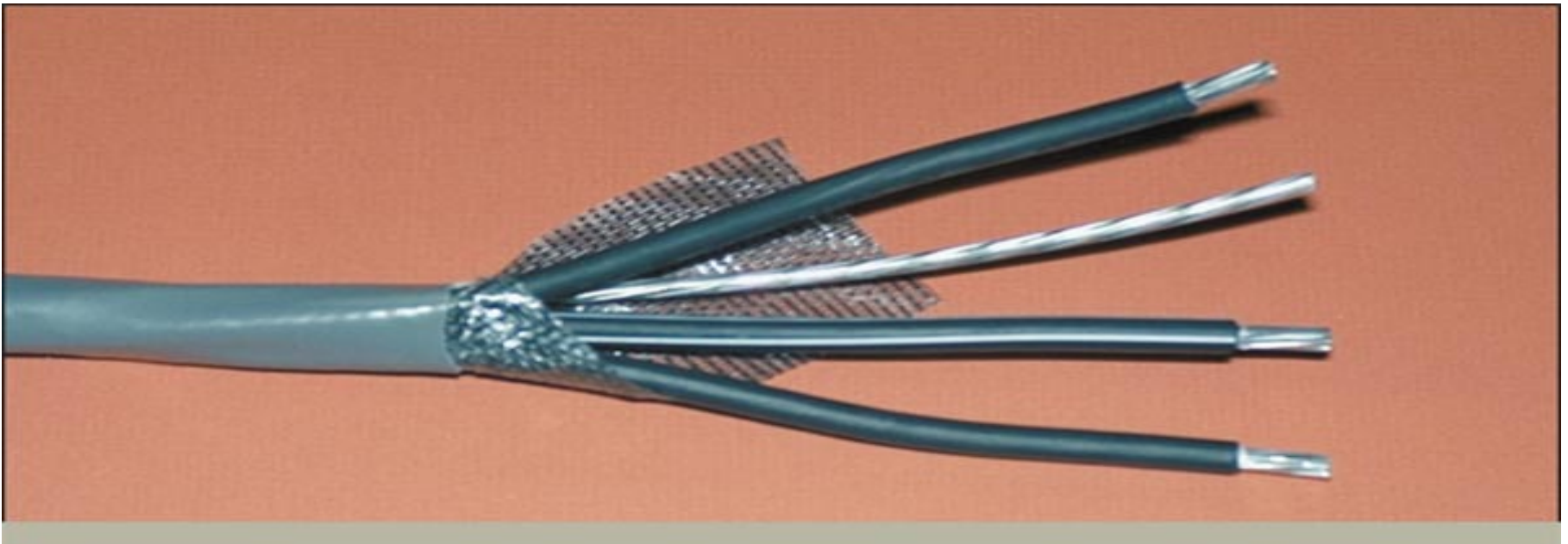
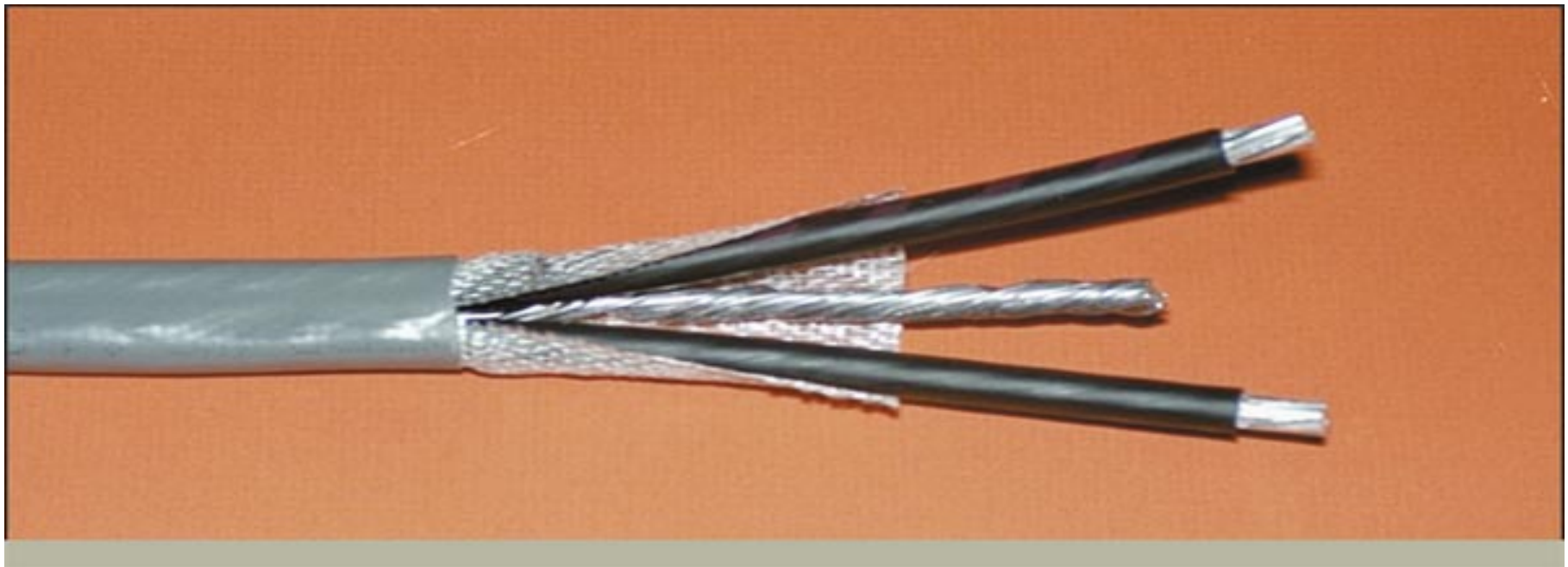

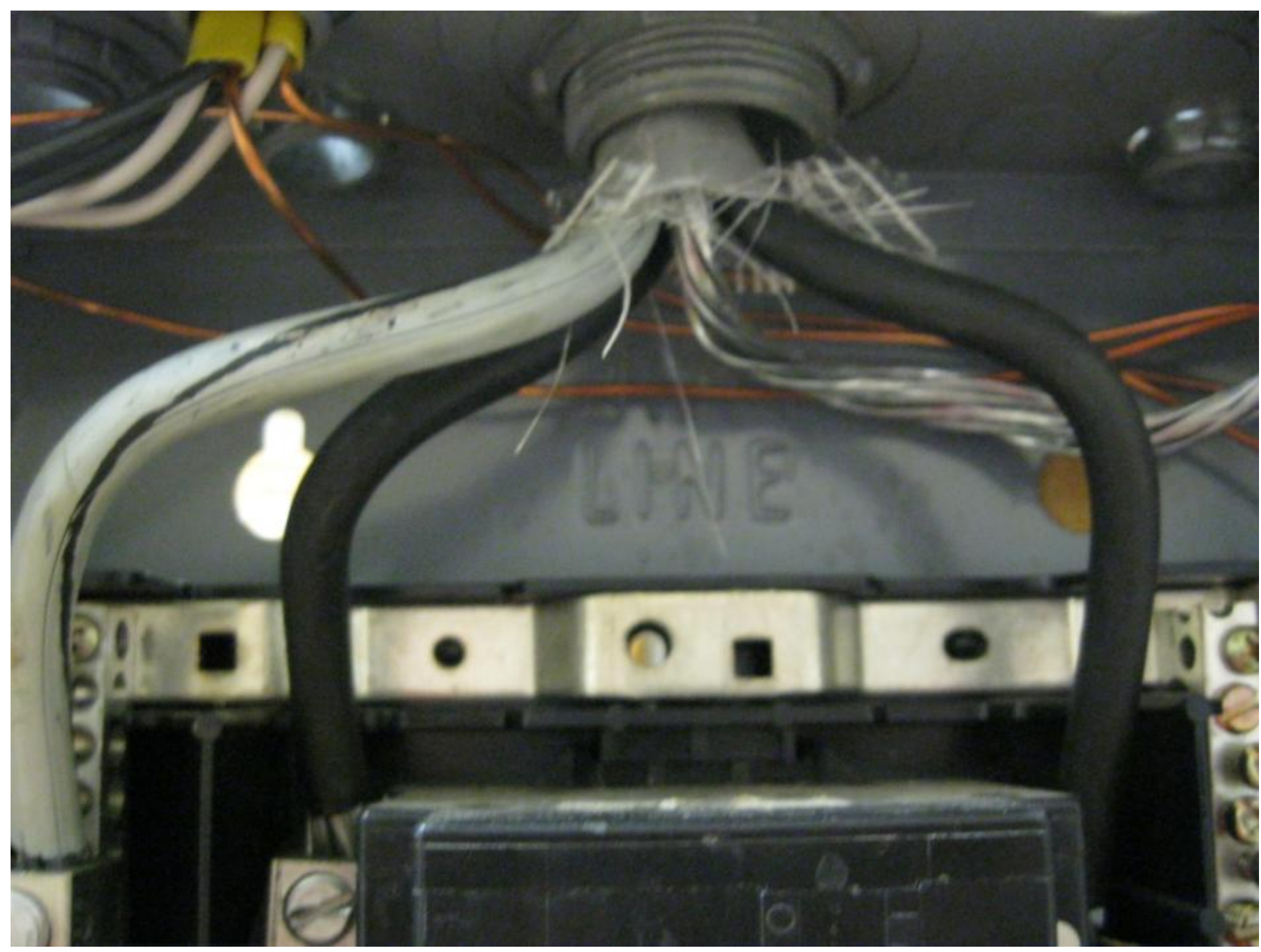

Examples of Table 400-5 (A)

1. A flexible cord is labeled 4/5 SJO. This indicates that there are a total of 5 conductors in the cable and the size of each conductor would be no. 4 AWG copper. In this cable there are 3 current carrying conductors, a neutral conductor, and equipment-grounding conductor. Using subheading "A" (3 or more conductor cords) of Table 400-5(A) and the no.4 AWG conductor size, the allowable ampacity would be 60 Amps.

2. A 6/4 SO flexible cord has 4 no.6 AWG conductors (2 current carrying, 1 neutral, 1 equipment ground) using subheading "B" (2 conductor cords) the no. 6 AWG conductors size of allowable ampacity would be 55 Amps.

4/5 sjo wire

Means

of wires 5 wires
 [conductors]

4 gauge size awg
 [American wire gage]

Cords and cables

Wiring Methods.

(A) Type. Where flexible cords or cables are used, they shall be listed for extra-hard usage. Where flexible cords or cables are used and are not subject to physical damage, they shall be permitted to be listed for hard usage. Where used outdoors, flexible cords and cables shall also be listed for wet locations and shall be sunlight resistant. Extra-hard usage flexible cords or cables shall be permitted for use as permanent wiring on portable amusement rides and attractions where not subject to physical damage.

(B) Single-Conductor. Single-conductor cable shall be permitted only in sizes 2 AWG or larger.

(C) Open Conductors. Open conductors are prohibited except as part of a listed assembly or festoon lighting installed in accordance with Article 225.

(D) Splices. Flexible cords or cables shall be continuous without splice or tap between boxes or fittings.

(E) Cord Connectors. Cord connectors shall not be laid on the ground unless listed for wet locations. Connectors and cable connections shall not be placed in audience traffic paths or within areas accessible to the public unless guarded.

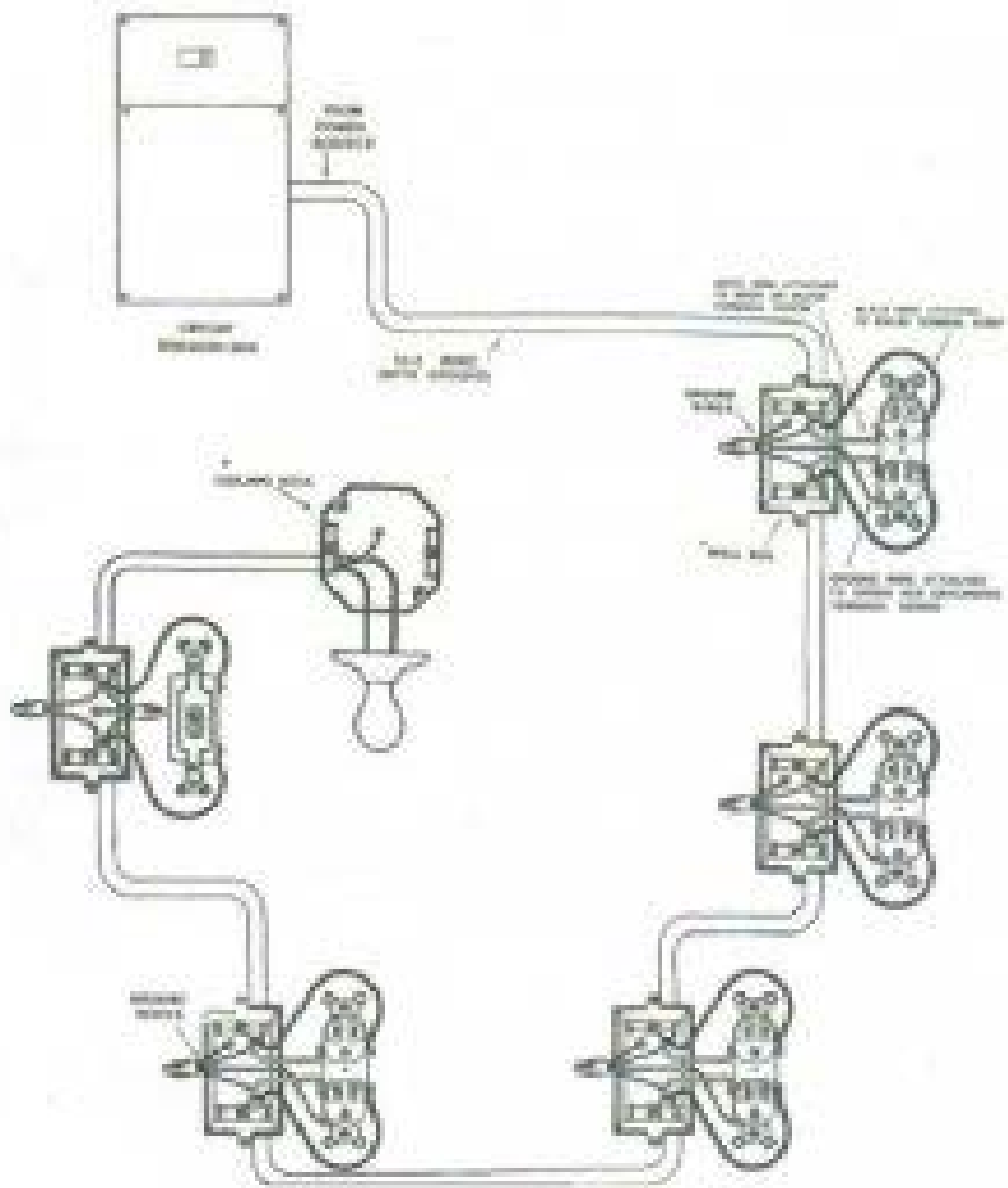

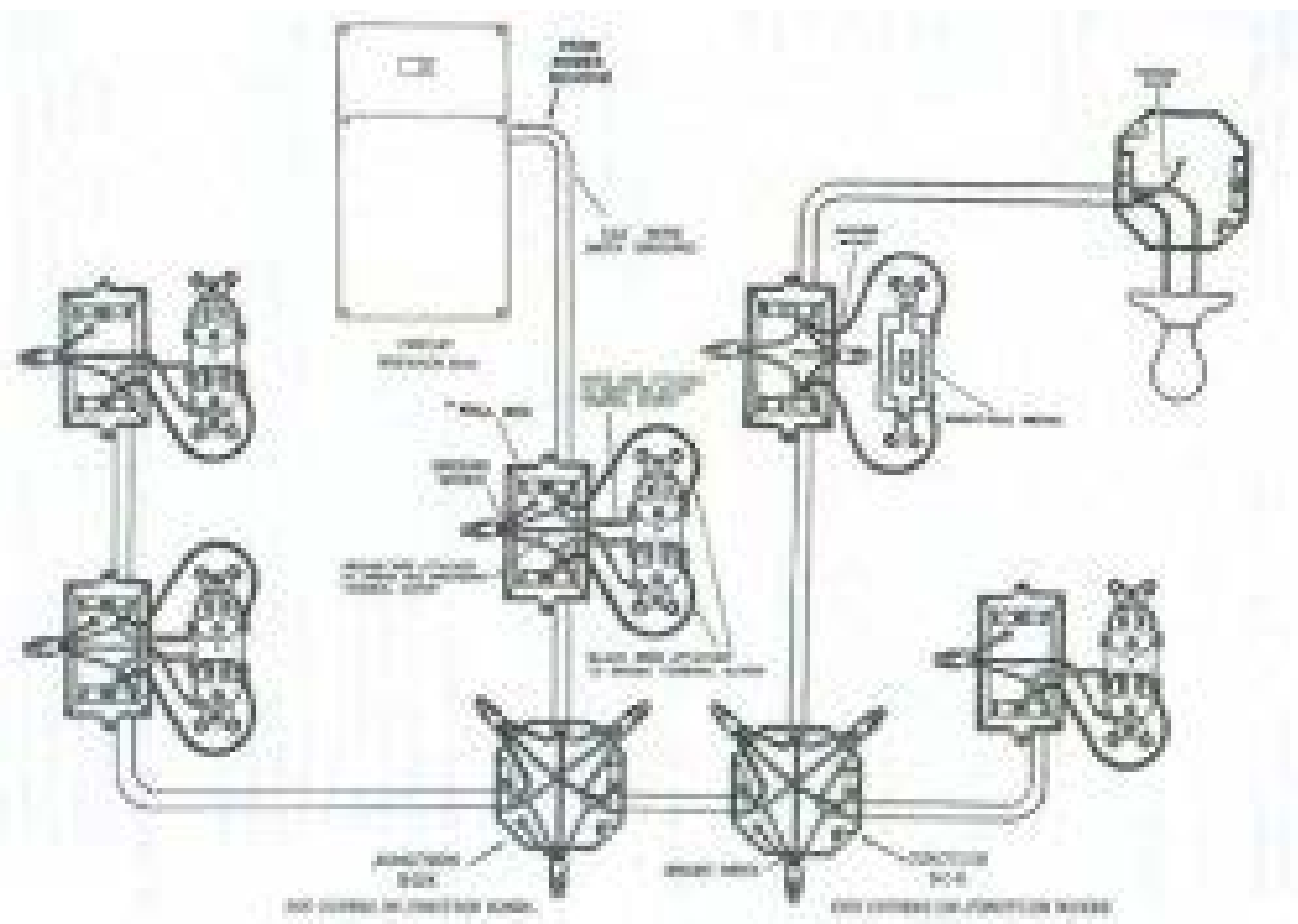

HYDRAULIC SYSTEM

CONTROL SYSTEM

With Switch Controlling One Light

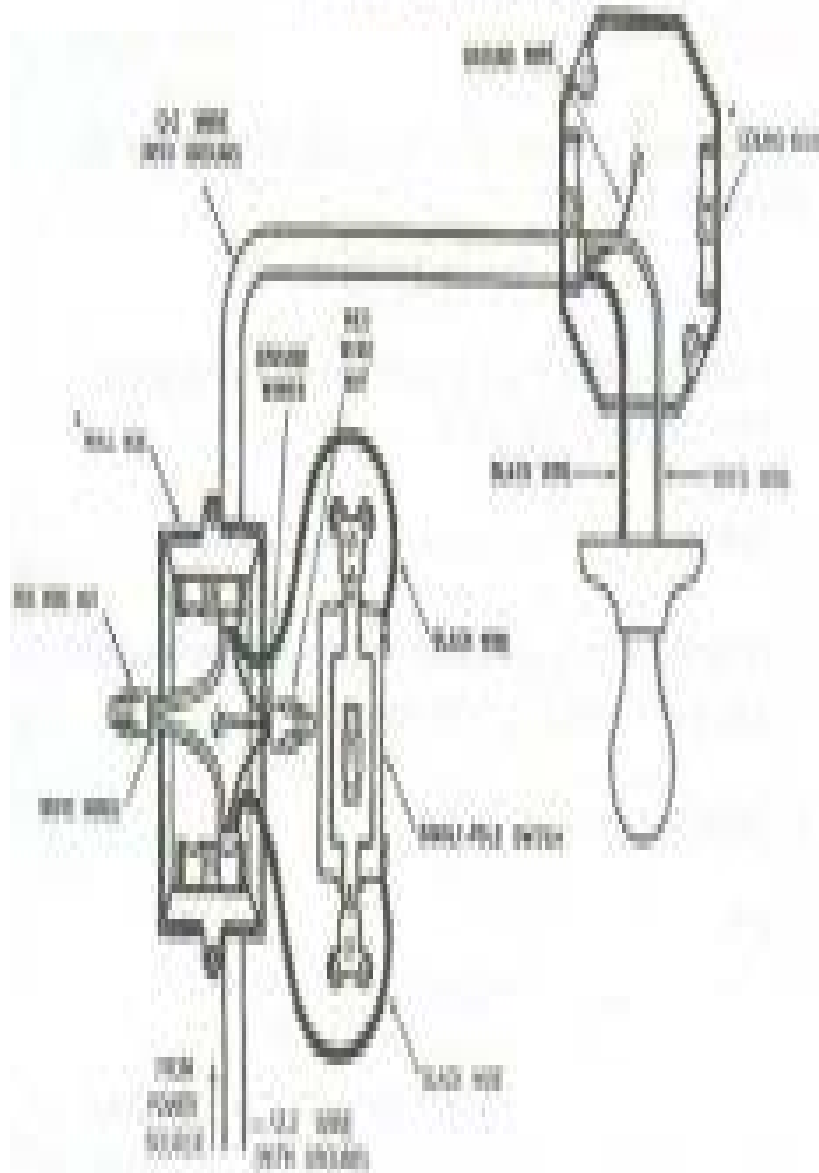

Single Pole Switch With Switch Controlling One Light

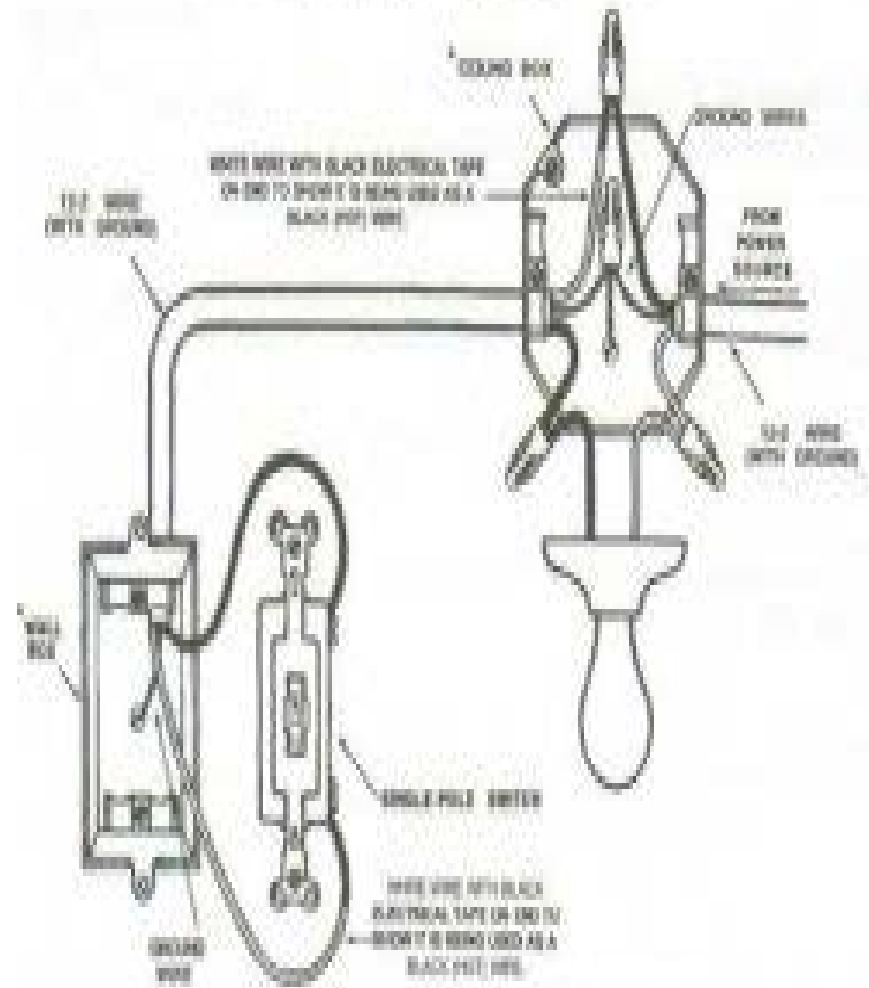

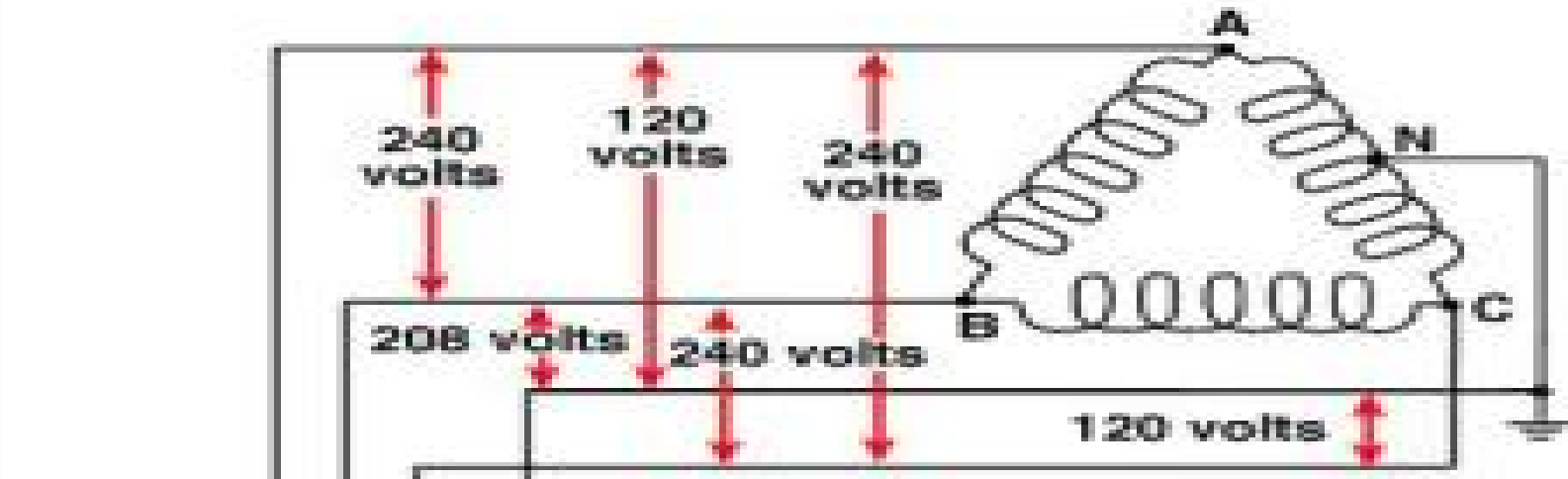

A - B	240 volts
B - C	240 volts
C - A	240 volts
A - N	120 volts
B - N	208 volts
C - N	120 volts

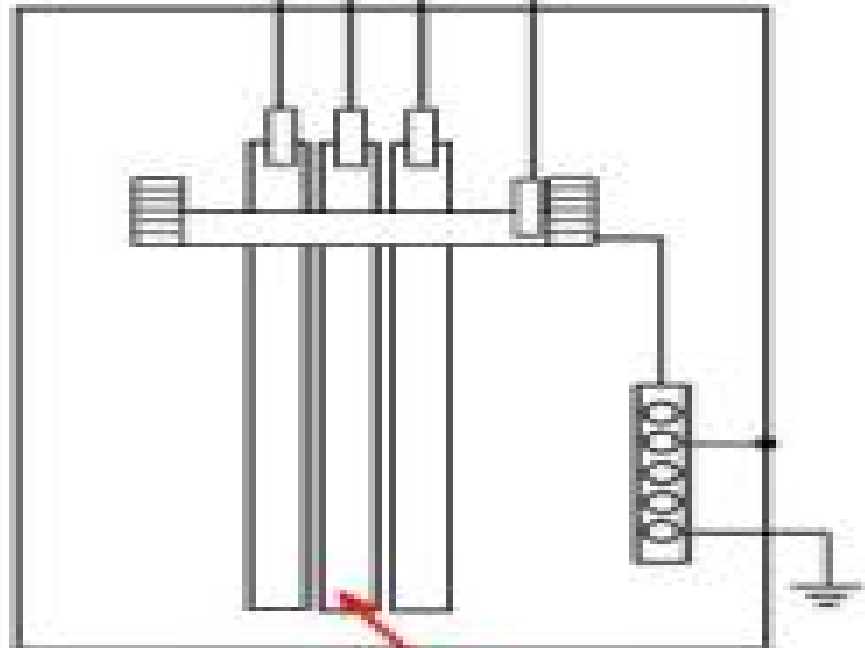

"B" PHASE BUS BAR

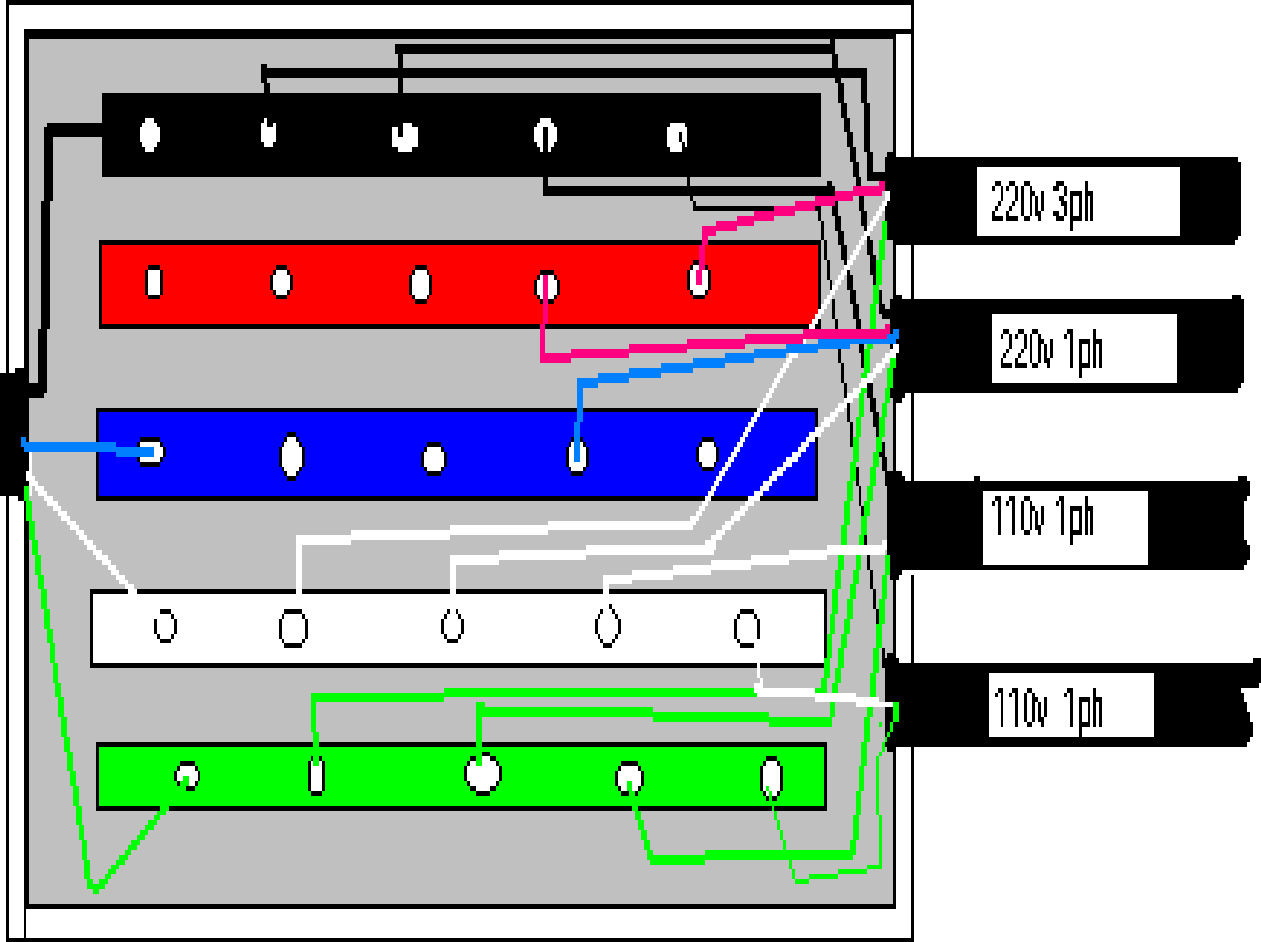

AFCIs

vs.

GFCIs:

Arc

Fault

Circuit

Interrupter



GROUNDING
PIGTAIL

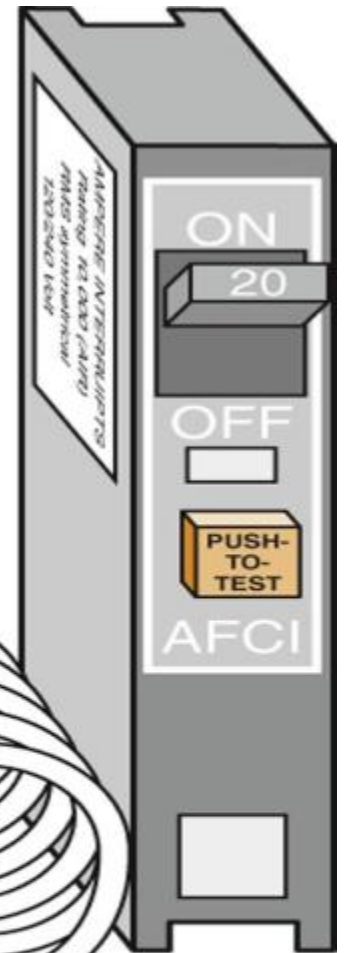
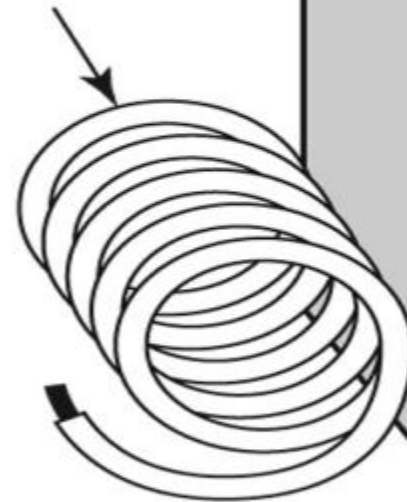

A SINGLE-POLE
ARC FAULT CIRCUIT
INTERRUPTER
CIRCUIT BREAKER

(A)

Ground

Fault

Circuit

Interrupter

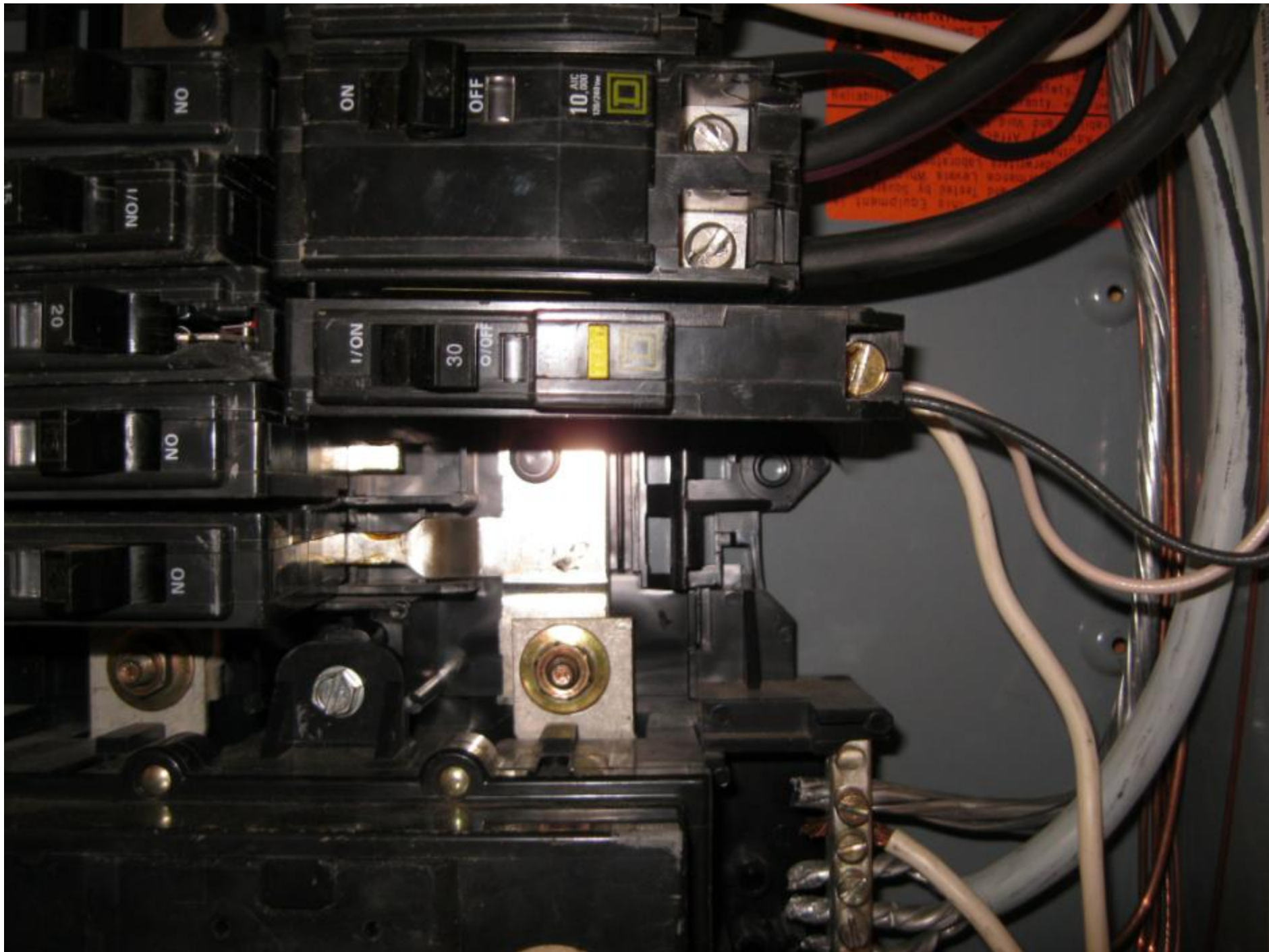



GROUND
PIGTAIL

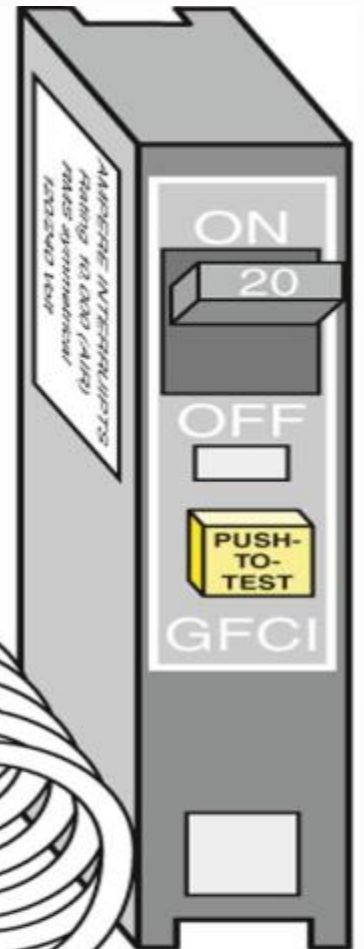
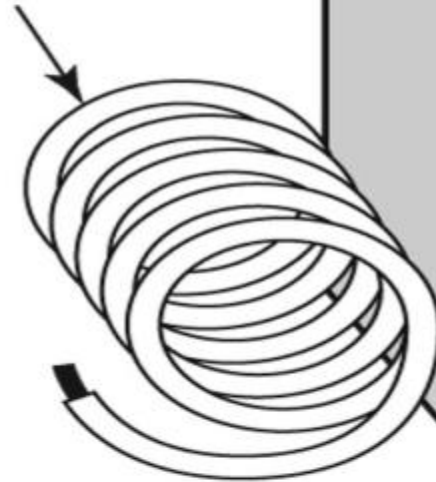

A SINGLE-POLE
GROUND FAULT
CIRCUIT INTERRUPTER
(A) CIRCUIT BREAKER

AFCIs vs. GFCIs:

What is the difference between an
Arc Fault Circuit Interrupter
and
a Ground Fault Circuit Interrupter?

An AFCI is a device intended to prevent a fire.

It detects a type of arcing in the electrical circuit that can lead to overheating and a fire.

An **AFCI can protect against some types of shock by detecting a short circuit**

if the short is also affecting an individual, but it is not designed as a shock protector and

will not detect all of the same faults as a GFCI.

A GFCI is a device intended to prevent electrical shock.

A GFCI will not necessarily detect the type of electrical arcing that can cause a fire.

The **GFCI** is designed to **protect people from severe or fatal electric shocks** while the **AFCI** protects against fires **caused by arcing faults.**

The GFCI also can protect against some electrical fires by detecting arcing and other faults to ground but cannot detect hazardous across-the-line arcing faults that can cause fires.

A ground fault

is an unintentional electric path diverting current to ground.
Ground faults occur when current leaks from a circuit.

How the current leaks is very important.

If a person's body provides a path to ground for this leakage,
the person could be injured, burned, severely shocked,
or electrocuted.

The National Electrical Code requires GFCI protection for receptacles located
outdoors,
in bathrooms, garages, kitchens, crawl spaces and
unfinished basements;
and at certain locations such as near swimming pools.

Grounding to trip the circuit breaker or blow the fuse:

Electrical grounding is necessary to protect people from electric shock

by providing a good electrical path to route a faulty electrical connection

(such as a short circuit) to ground (literally, to the earth)

so that current will flow through

and thus trip the circuit breaker or blow the fuse, safely and quickly turning off the electrical circuit.

(A short circuit is one of the two ways that a fuse or circuit breaker will blow.

The second is the drawing of more current (amps) than the circuit is intended to carry.)

Grounding to route stray electricity from static electricity, electrical power surges, lightning, etc. to ground.

This can protect the insulation on electrical wires from damage due to high voltage.

The protection against static electricity helps reduce the chances of an un-wanted spark that can cause damage to electronic components or cause an explosion of nearby combustible gases.

Grounding to provide a normal path for electricity to flow:
energy flows in an building's electrical circuit from a power source
(the utility pole through electrical panel,
though building circuits and electrical devices connected to them)
to the ground, to earth.

If there is no good connection to earth,
electricity does not flow,
though it might if you stand on wet ground and touch a live electrical wire –
an action that could be fatal.

Ground and neutral are related electrical terms.

Neutral is used to describe the "return path"
from in an electrical circuit to the electrical panel.

Inside of the main electrical panel
the neutral wires are bonded
to the ground wires and
to a grounding conductor
that connects that assembly to earth
(typically through a grounding electrode or
"ground rod")

GROUNDING

AND / OR

BONDING

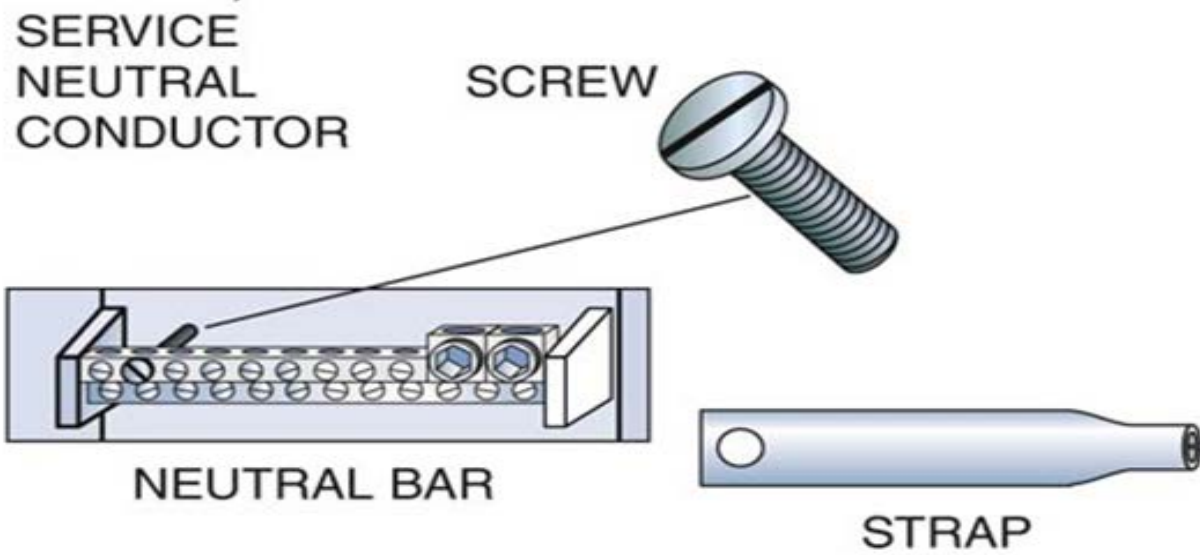
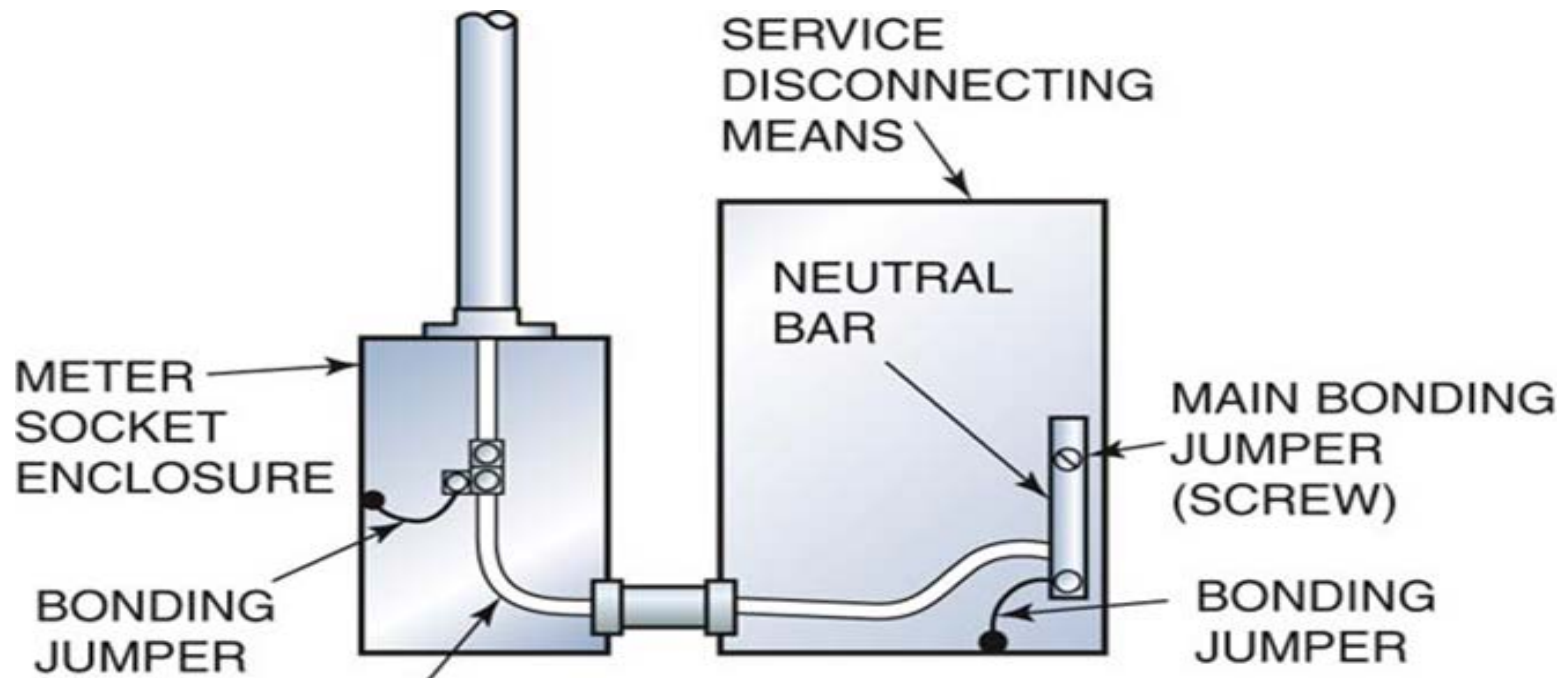

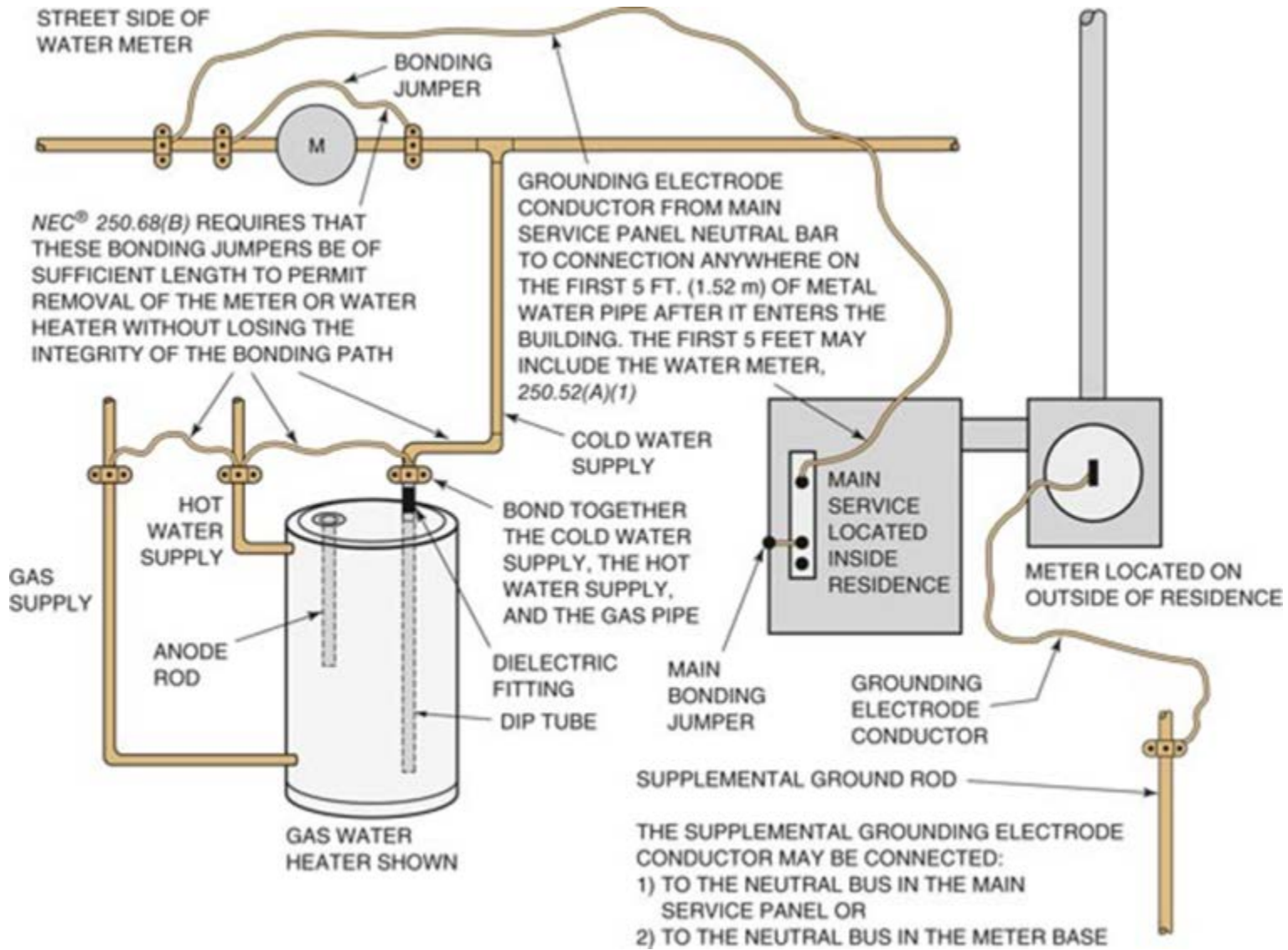

Ground:

means the physical earth,
the soil or ground.

In some countries the term earth is used and is synonymous with ground.

In the electrical code,
ground means an electrically conducting connection,
intentional or accidental,
between an electrical circuit and the earth.

Grounded means that something has been electrically connected to the earth.

Watch out:

even among inspectors and electricians,
people may use the term "ground"
more loosely to refer to the equipment grounding conductor
or other components.

Grounding electrode or ground electrode:

a metal conductor,

usually a solid copper-alloy rod of specified length,
driven into the ground in order to provide a point for electrical
connection

between the building grounding system
and ground or earth.

In the electrical code,

**the grounding electrode conductor is the conductor (a wire)
used to connect the grounding rod(s)
to the equipment grounding conductor**

(the ground bus and ground wires in the electrical panel)

OR to the grounded conductor

(the neutral bus and neutral wires)

OR to connect both of these to the grounding electrode
(which is usually the case in residential electrical systems).





Grounded Conductor (the neutral wire):

by convention the grounded conductor or neutral wire is **white or gray**.

In an electrical circuit the grounded conductor (white or neutral wire)

normally carries electrical current

between the un-grounded (hot) electrical wire

and (back through the main electrical panel and grounding system) earth.

In the electrical code,

a grounded conductor

is one which has been intentionally grounded

- connected to the earth.

The amount of current carried by **the neutral wire** is called the un-balanced load and depends on the characteristics of the electrical device being operated by the circuit.

The neutral conductor is grounded in the main electrical panel. Be careful, inspectors and electricians, speaking loosely, may simply call this the "neutral wire".

Equipment Grounding Conductor (the ground wire):

By convention the equipment grounding conductor (ground wire) is bare copper or carries green insulation.

the individual wire in a (grounded) electrical circuit that is connected through the ground bus in the electrical panels and ultimately in the main electrical panel is connected to ground or earth.

In the electrical code, a grounding conductor is a conductor (metal wire, metal bar, etc) which is used to connect electrical equipment (like an electrical panel enclosure) or the grounded circuit (the neutral wires) of a wiring system to a grounding electrode (and thus to earth).

The ground wire in an electrical circuit does not normally carry any electrical current, but it remains available as an emergency path to allow current to flow to earth should an electrical fault such as a short circuit occur (a connection between a hot wire and some metal (conductive) material that could cause an electrical shock to someone), thus assuring that a fuse or circuit breaker in the main panel can sense the current flow and switch off the circuit.

In an older two-wire armored cable (BX) electrical circuit, the metallic cable of the circuit may be serving as the only grounding conductor.

It helps to keep these terms straight
if we remember that we use
the **ing** form
of the word **grounding**
to mean that this conductor causes an electrical
connection
between earth
and whatever the grounding conductor
is connected to.



Grounding and bonding

You must bond the following equipment together, if they are connected to the same power source [525.30]:

Metal raceways and metal-sheath cables.

Metal enclosures.

Metal frames and metal parts of rides, concessions, tents, trailers, trucks, or other equipment that contain or support electrical equipment.

Ground the metal parts of all electrical equipment to the grounded (neutral) conductor at the service disconnecting means per 250.24(C) (or the separately derived system per 250.30(A)(1)) [525.31].

Bonding or Bonded:

means that metallic parts
are permanently joined

so as to assure that they form a reliably continuous electrical path and that the parts are capable of conducting any electrical current that may be imposed on them.

A bonding jumper

is a reliable electrical conductor used to connect metal parts together

and a **main bonding jumper**

is the connection between the grounded circuit conductor and the equipment grounding conductor at the electrical service (panel).

Ground bond:

refers to a physical electrical connection
between any metal component

(like metal water pipes,

metal gas piping,

a metal electrical panel enclosure,

or a neutral or ground bus in the main electrical panel)
and the building electrical ground system.

In the main electrical panel
the neutral wires
are physically bonded
to the ground wires
(by a larger diameter wire or by a metal bar inside the panel)
and the ground wire bus
(a metal bar)
is further connected to a grounding conductor
that connects those components to the building ground system:
one or more grounding electrodes
and possibly a connection to an incoming metal water pipe that is
buried outside.

An electrician would say that the building's ground
and neutral wires are bonded to earth

Bonding electrical components together

makes certain that all of the joined items are at the same
electrical potential

(that is, that current will not flow from one to the other).

Examples of electrical bonds in buildings include:

In individual electrical panels or sub-panels
the ground wires

are

all bonded together on a ground bus or bar.

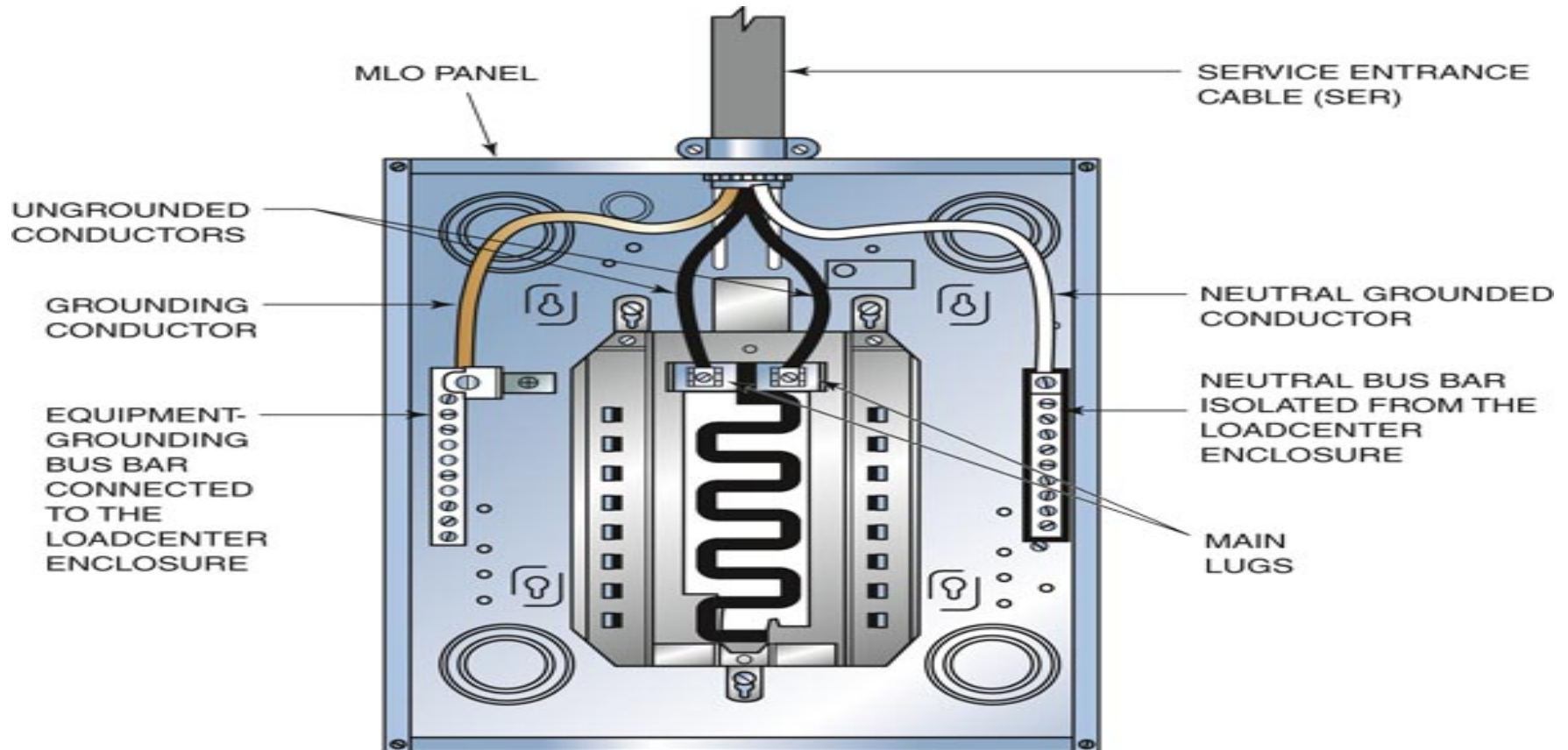

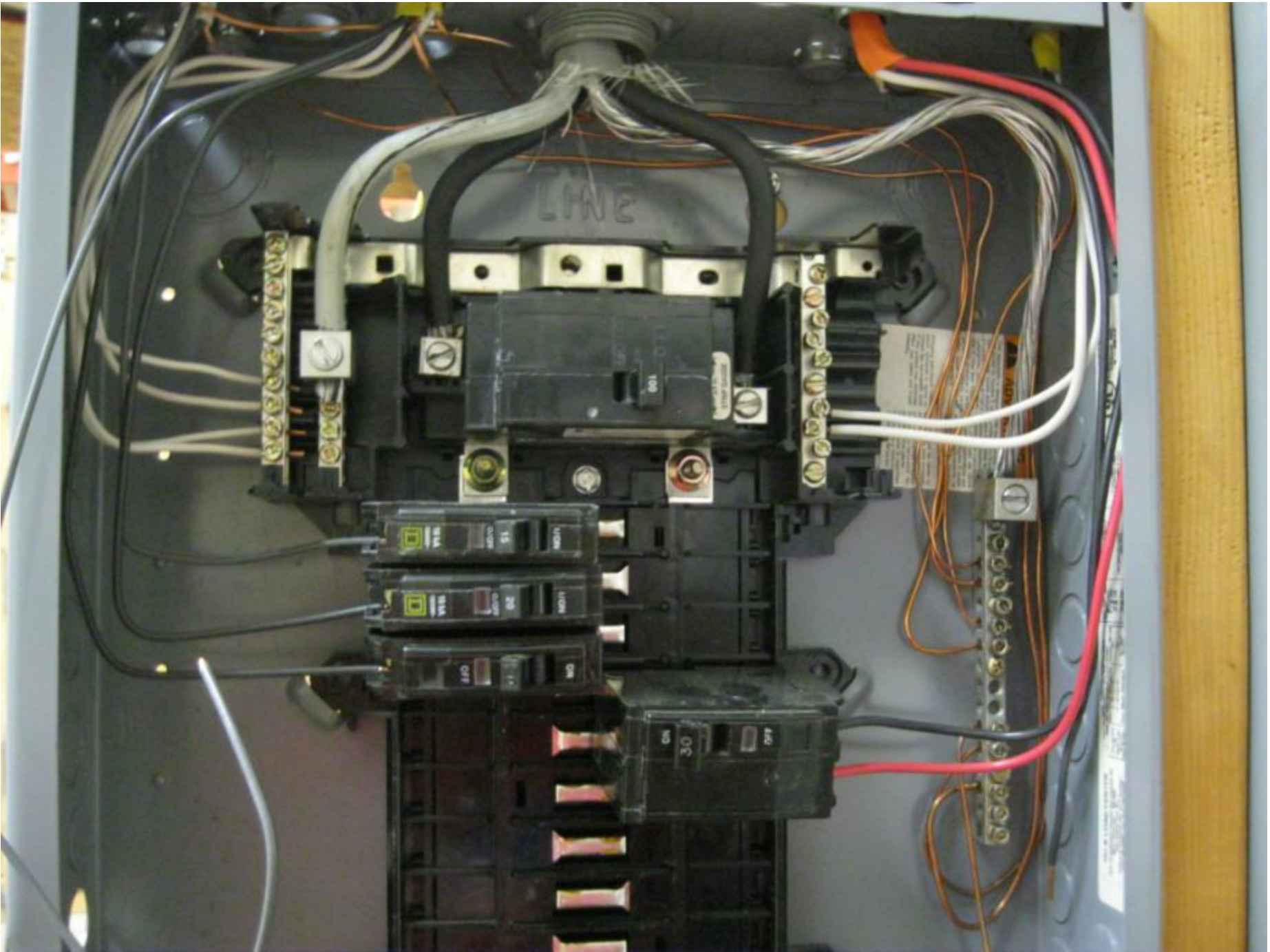

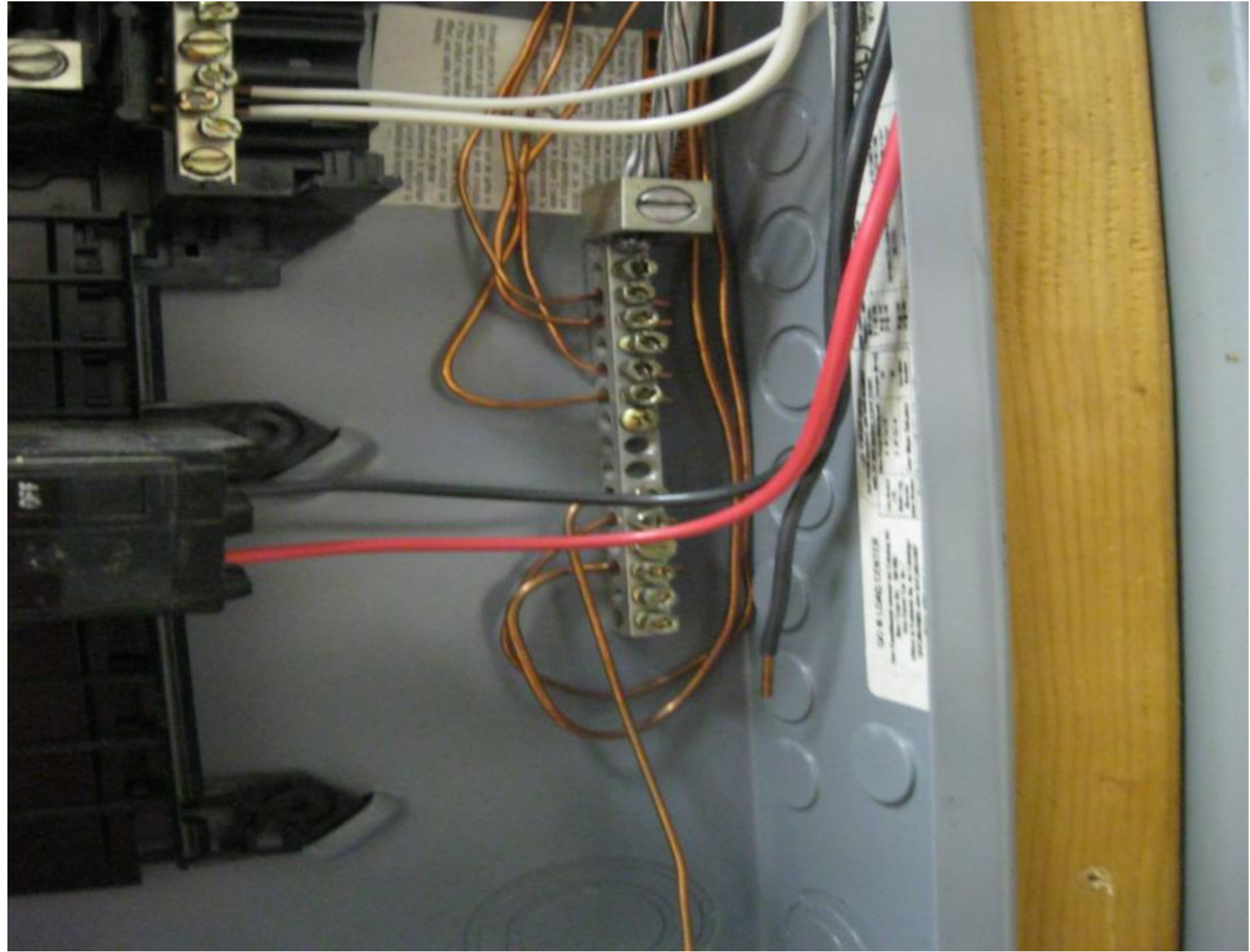

In the main electrical panel at a building,
the neutral bus
and ground bus
and electrical panel itself

are

all bonded together
and are connected to the building grounding system.

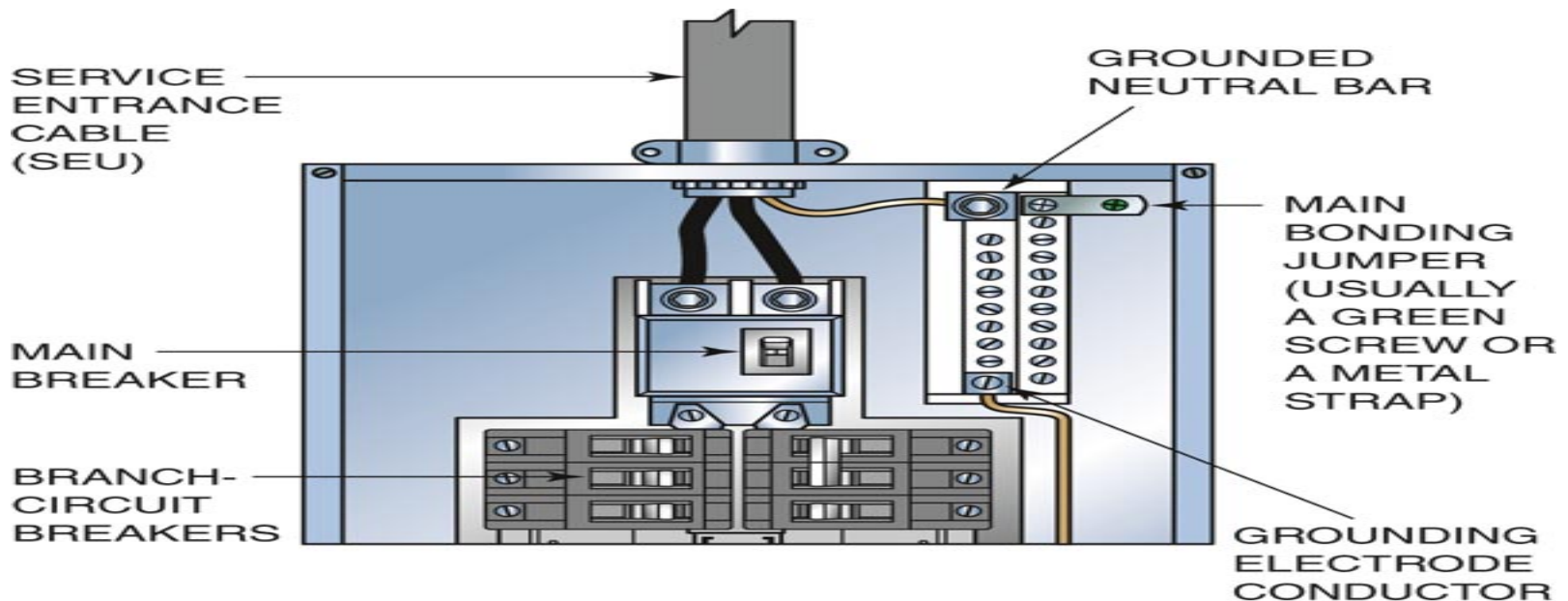

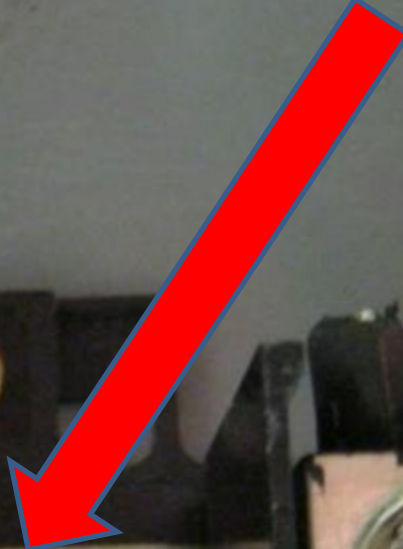

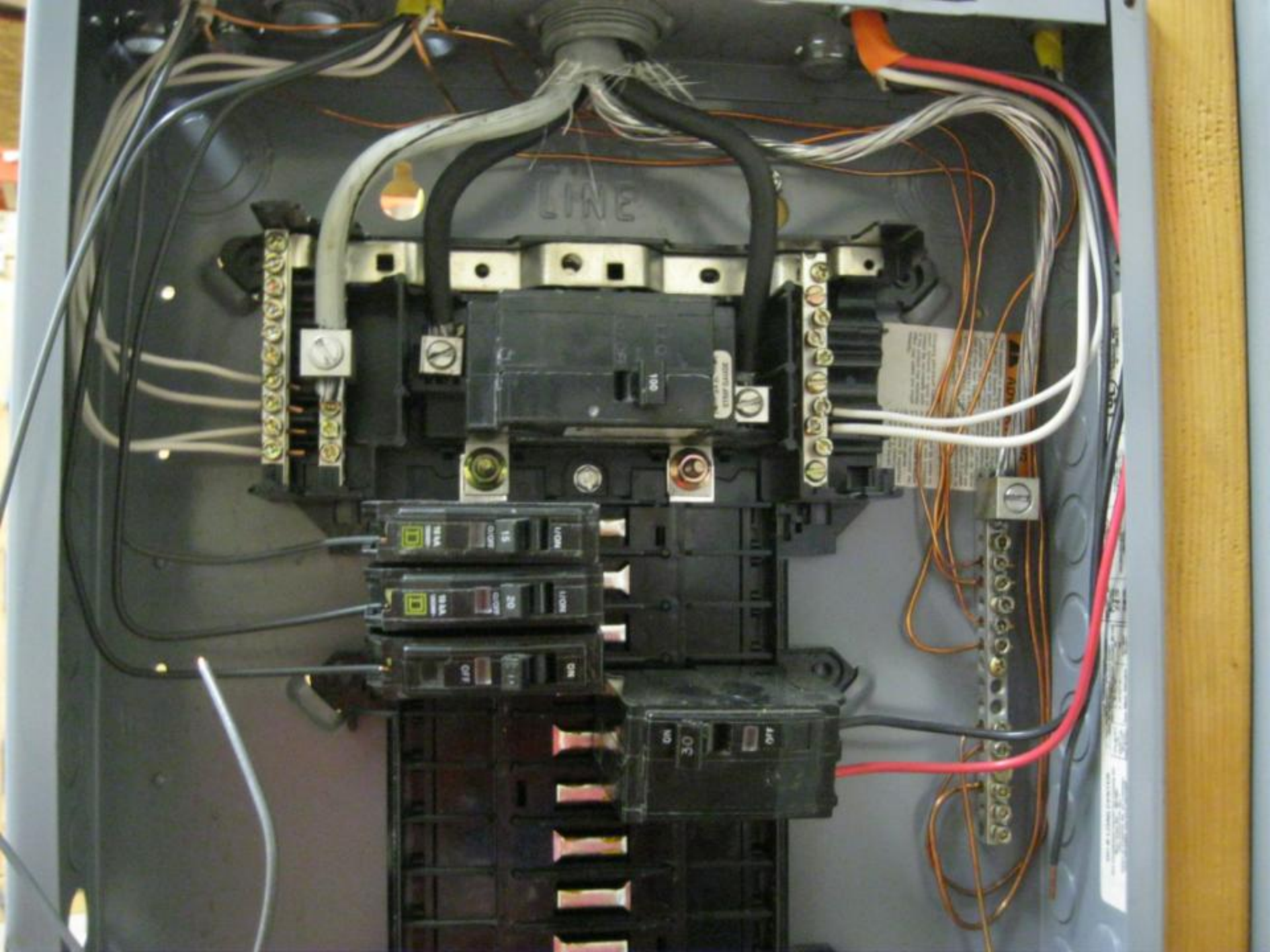

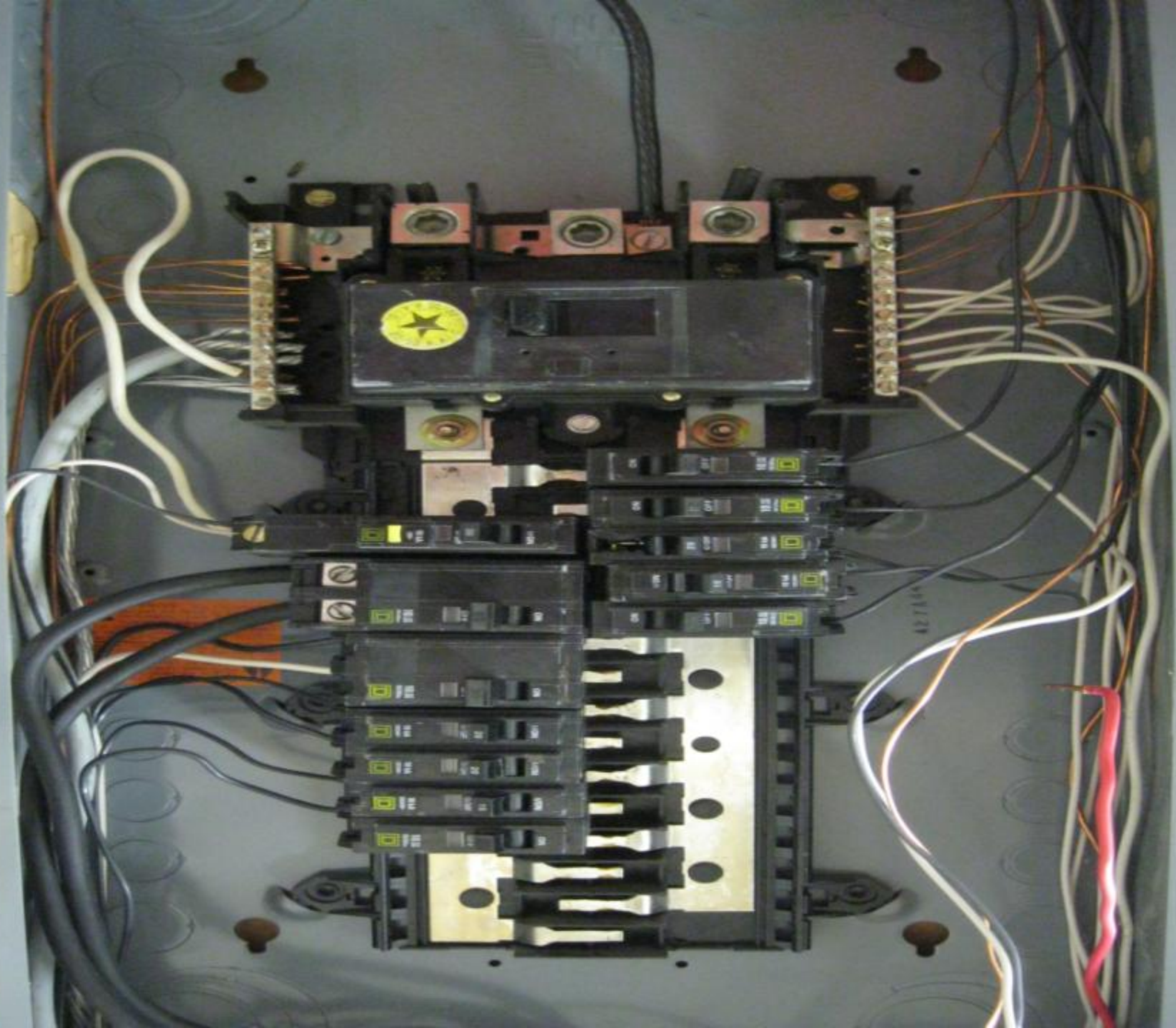

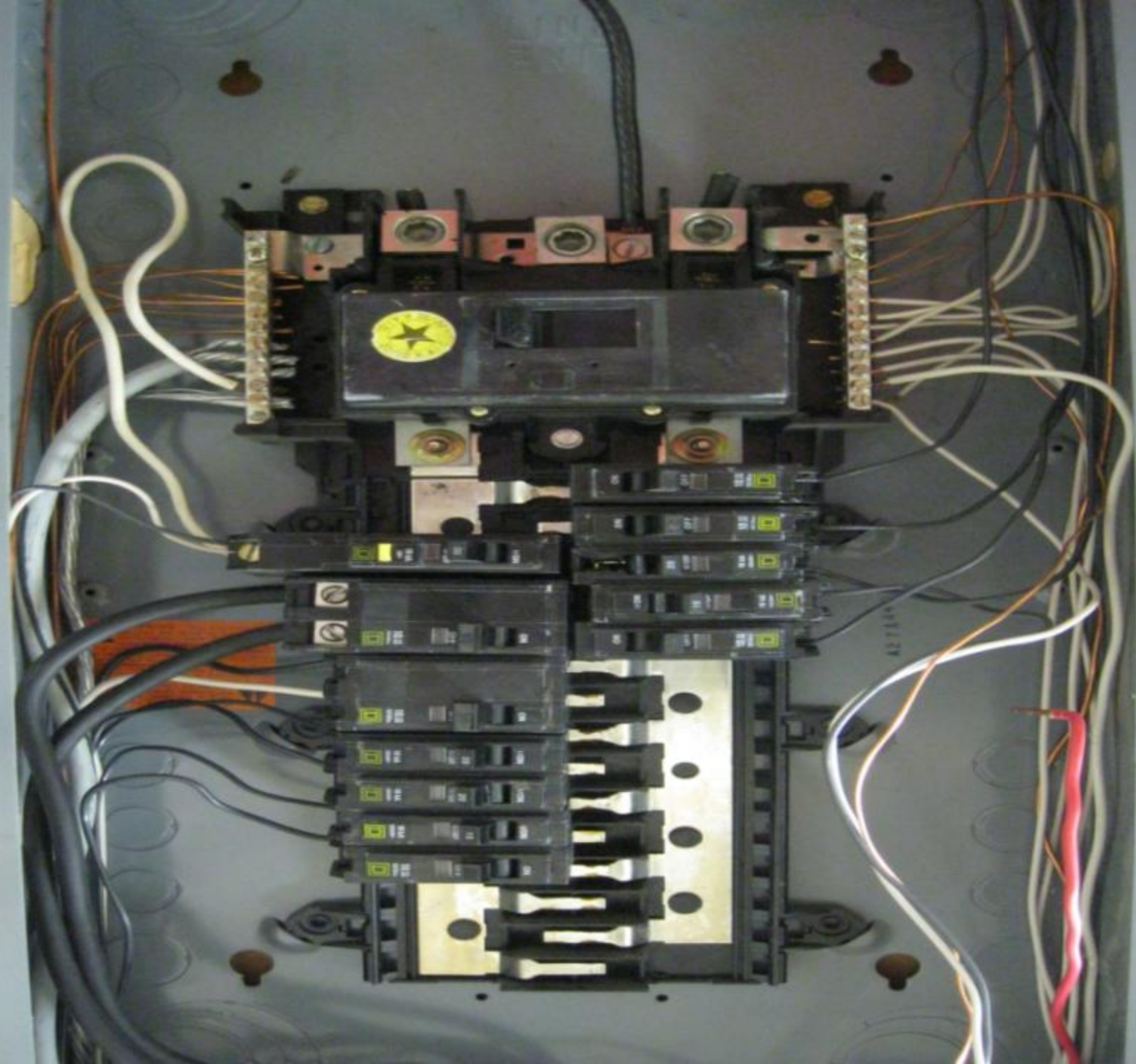

the neutral bus and ground bus

are not

bonded together and
must be kept separate.

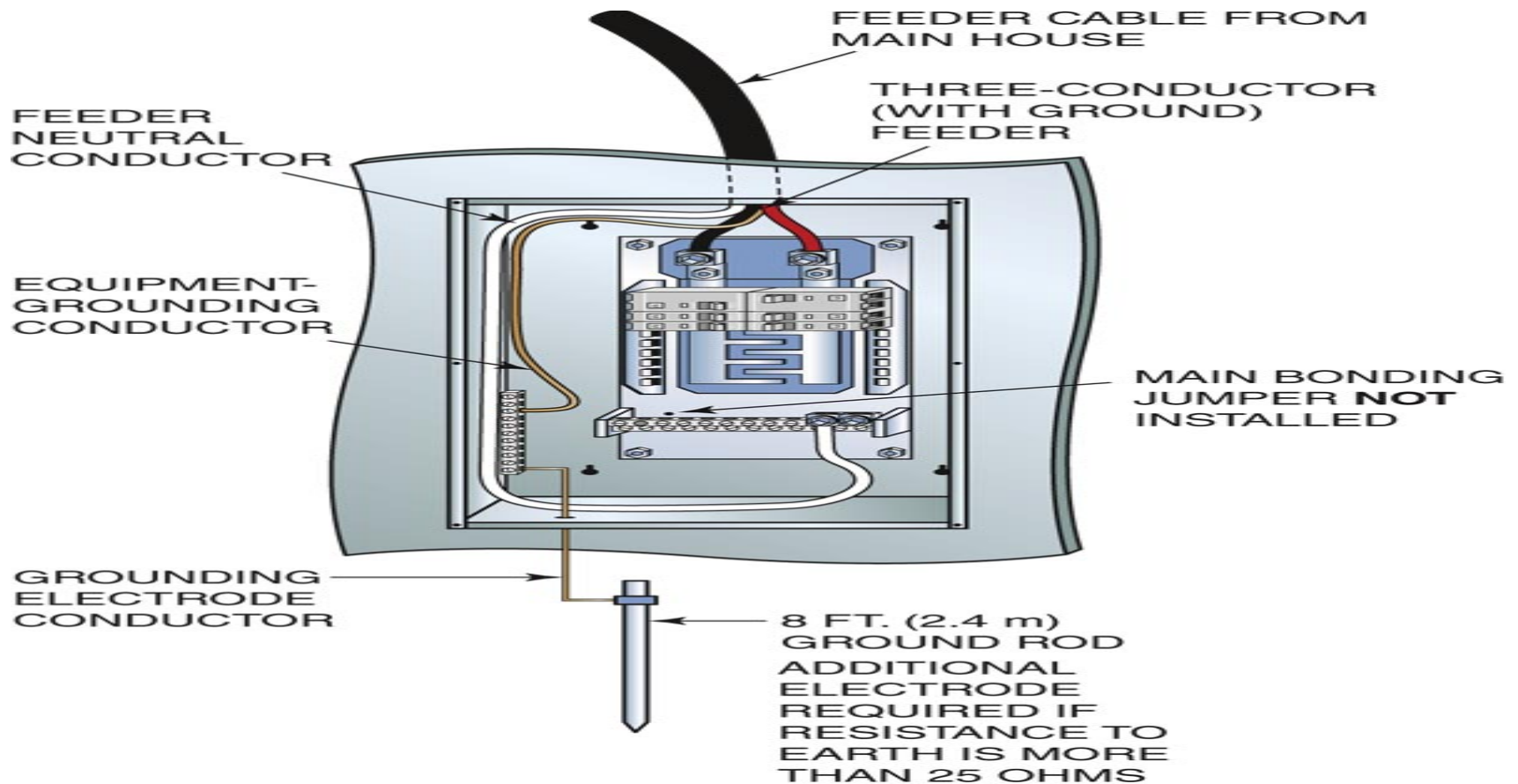

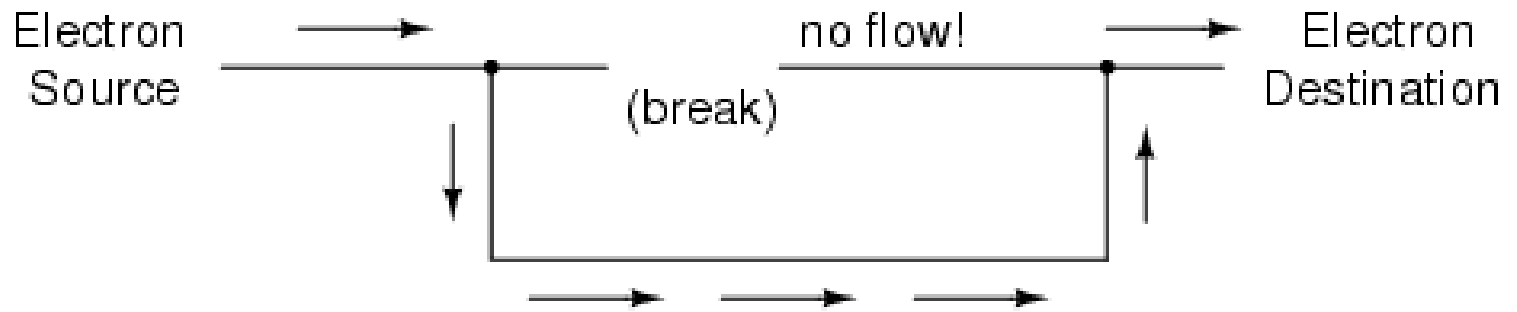

Without two contact points on the body for current to enter and exit, respectively, there is no hazard of shock.

This is why birds can safely rest on high-voltage power lines without getting shocked: they make contact with the circuit at only one point.

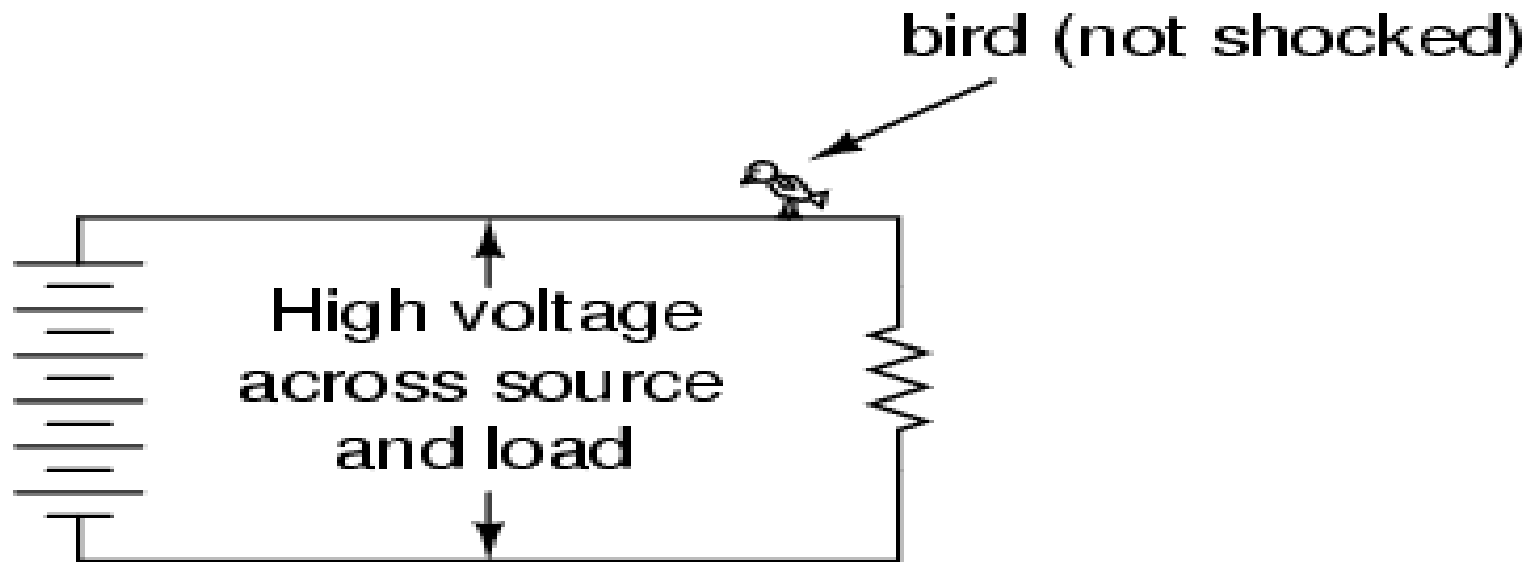

In order for electrons to flow through a conductor, there must be a voltage present to motivate them. Voltage, as you should recall, is always relative between two points.

There is no such thing as voltage "on" or "at" a single point in the circuit, and so the bird contacting a single point in the above circuit has no voltage applied across its body to establish a current through it. Yes, even though they rest on two feet, both feet are touching the same wire, making them electrically common. Electrically speaking, both of the bird's feet touch the same point, hence there is no voltage between them to motivate current through the bird's body.

This might lead one to believe that it's impossible to be shocked by electricity by only touching a single wire. Like the birds, if we're sure to touch only one wire at a time, we'll be safe, right? Unfortunately, this is not correct. Unlike birds, people are usually standing on the ground when they contact a "live" wire. Many times, one side of a power system will be intentionally connected to earth ground, and so the person touching a single wire is actually making contact between two points in the circuit (the wire and earth ground):

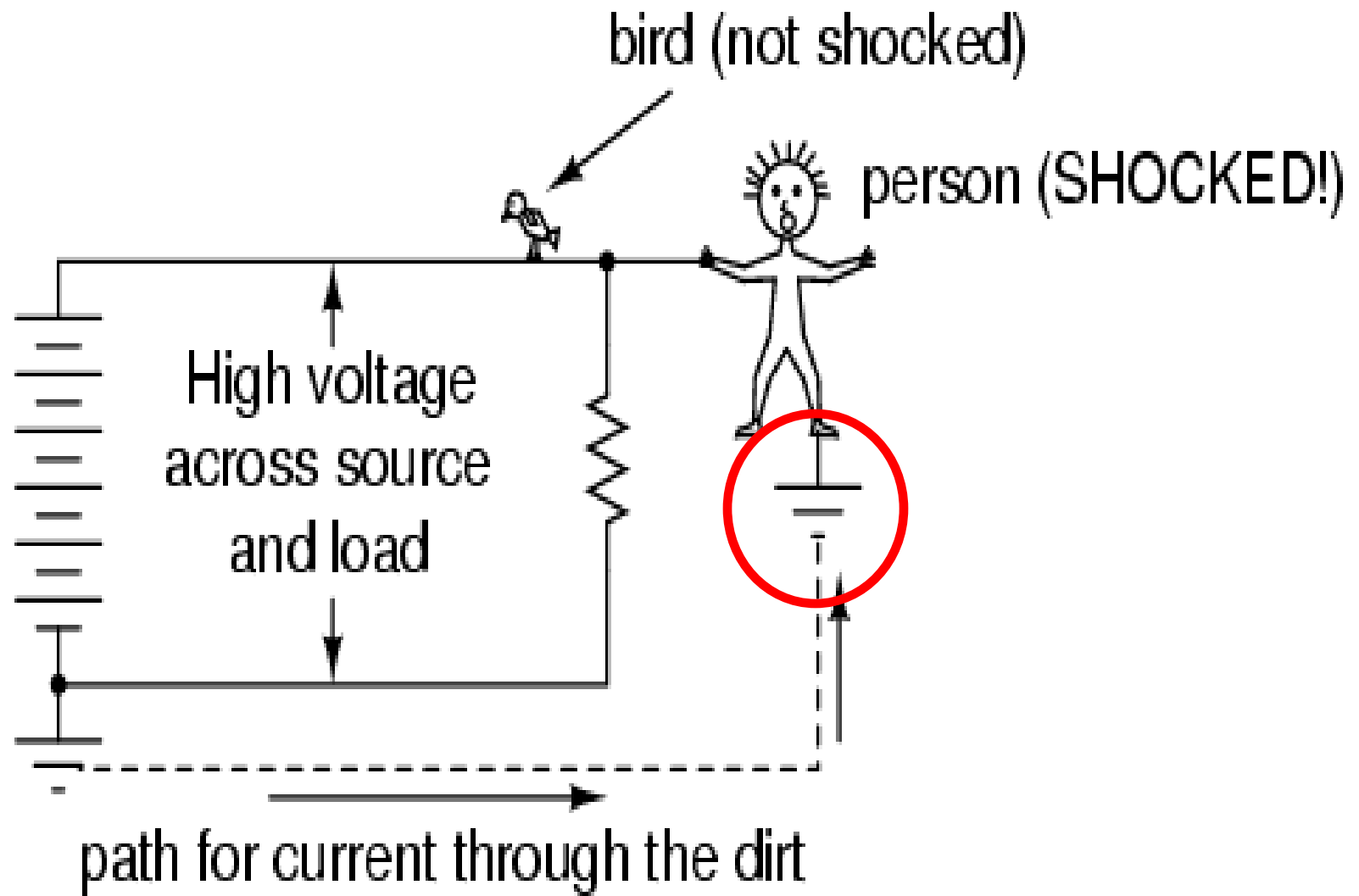

The ground symbol

is that set of three horizontal bars of decreasing width located at the lower-left of the circuit shown, and also at the foot of the person being shocked.

In real life the power system ground consists of some kind of metallic conductor buried deep in the ground for making maximum contact with the earth.

That conductor is electrically connected to an appropriate connection point on the circuit with thick wire.

The victim's ground connection is through their feet, which are touching the earth.

A few questions usually arise at this point in your mind :

1.If the presence of a ground point in the circuit provides an easy point of contact for someone to get shocked,
why have it in the circuit at all?
Wouldn't a ground-less circuit be safer?

2.The person getting shocked probably isn't bare-footed.

If rubber and fabric are insulating materials, then why aren't their shoes protecting them by preventing a circuit from forming?

3. How good of a conductor can dirt be?

If you can get shocked by current through the earth, why not use the earth as a conductor in our power circuits?

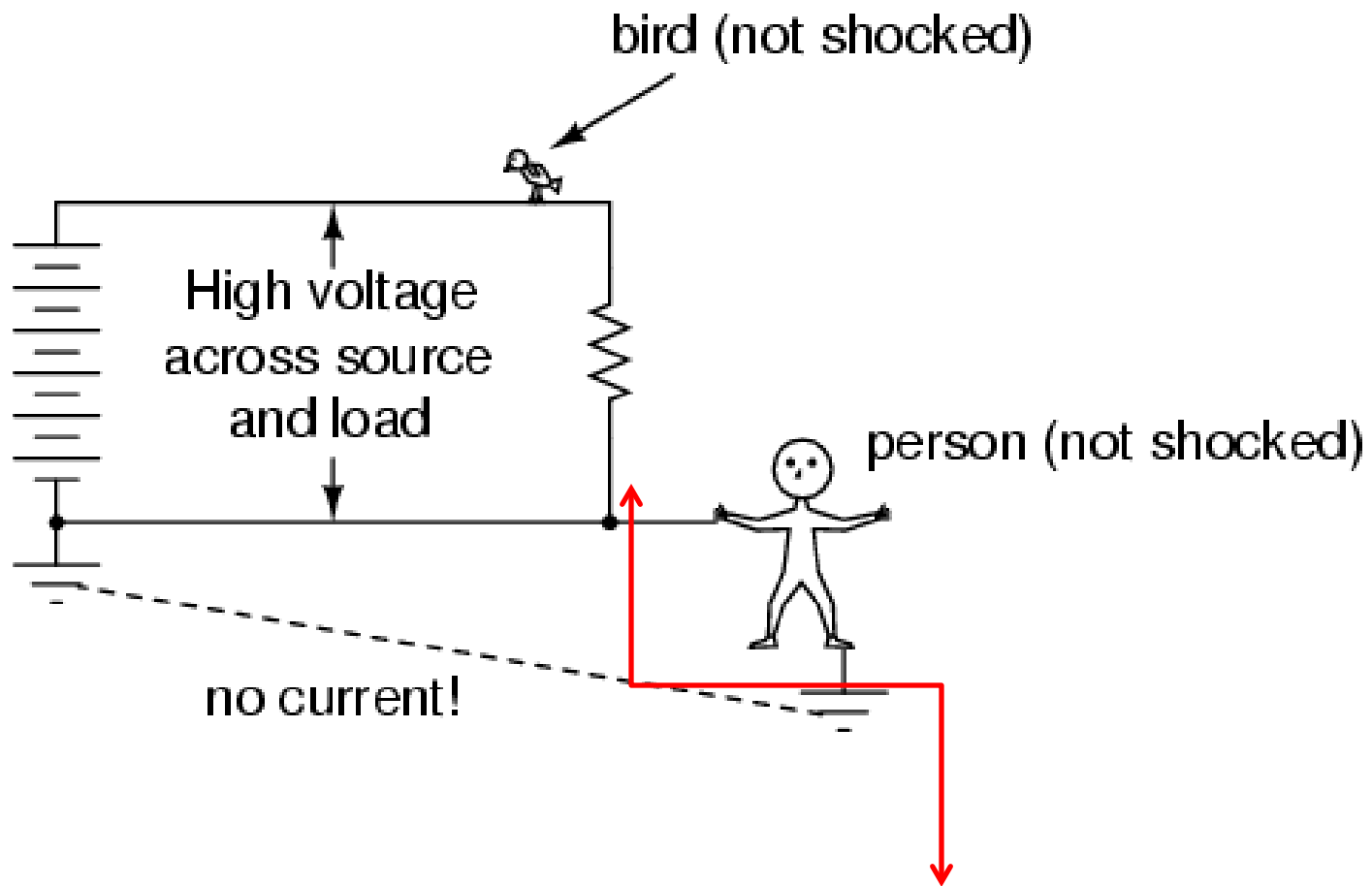

In answer to the first question,
the presence of an intentional "grounding" point in an electric
circuit
is intended to ensure that one side of it is safe to come in contact
with.

Note that if our victim in the above diagram
were to touch the bottom side of the resistor,
nothing would happen even though their feet would still be
contacting ground

Because the bottom side of the circuit is firmly connected to ground through the grounding point on the lower-left of the circuit, the lower conductor of the circuit is made electrically common with earth ground.

Since there can be no voltage between electrically common points, there will be no voltage applied across the person contacting the lower wire, and they will not receive a shock.

For the same reason, the wire connecting the circuit to the grounding rod/plates is usually left bare (no insulation), so that any metal object it brushes up against it will similarly be electrically common with the earth.

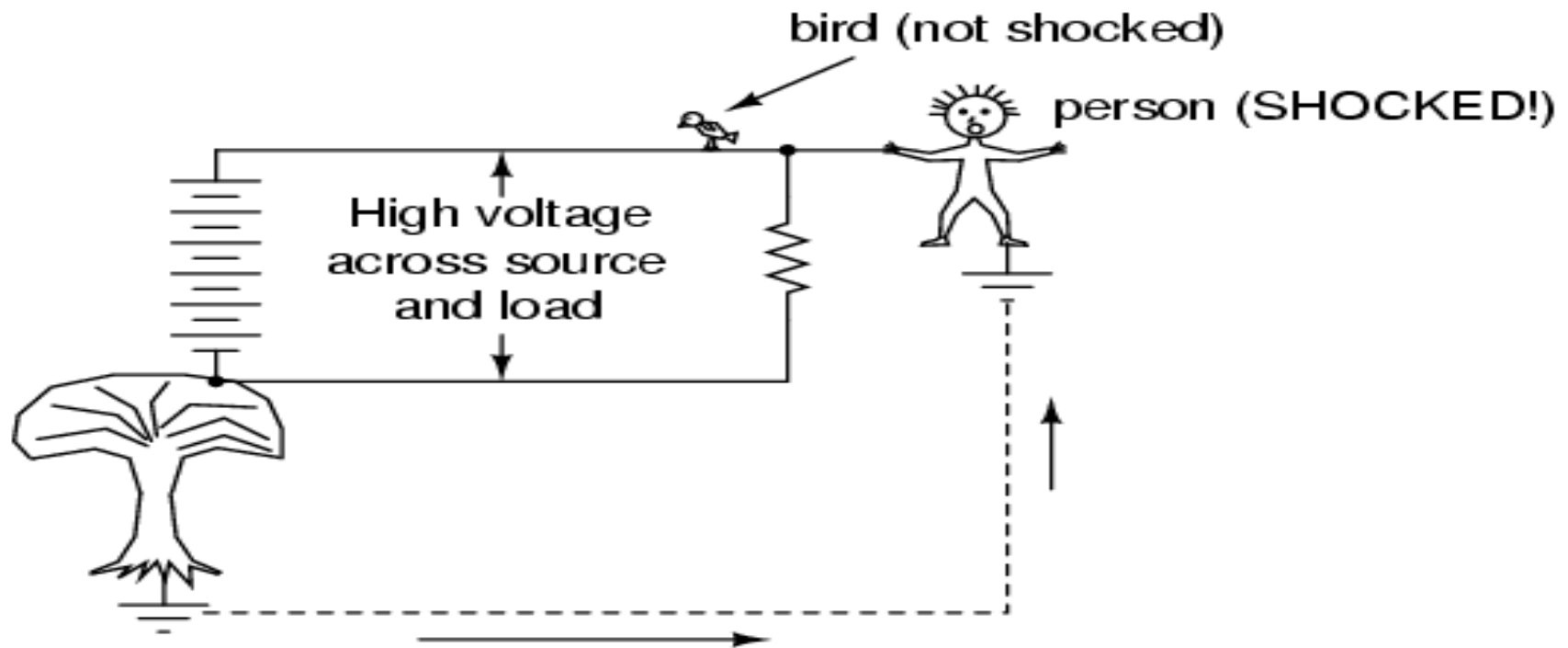
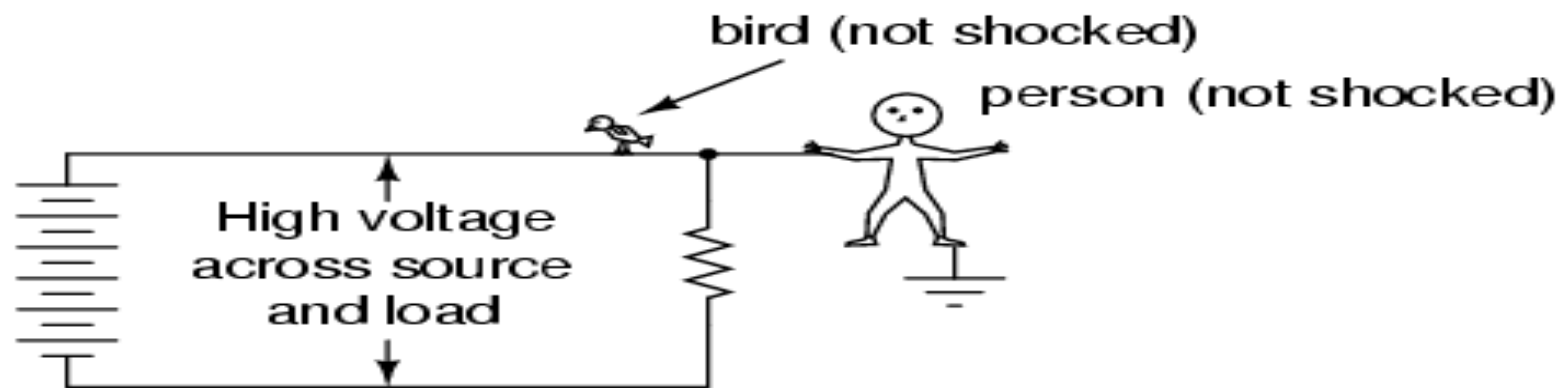

accidental ground path through tree (touching wire) completes the circuit for shock current through the victim.

accidental connection between a power system conductor and the earth (ground) is called a ground fault.

Ground faults may be caused by many things, including dirt buildup on power line insulators

(creating a dirty-water path for current from the conductor to the pole, and to the ground, when it rains),

ground water infiltration in buried power line conductors, and birds landing on power lines, bridging the line to the pole with their wings.

Given the many causes of ground faults,
they tend to be unpredictable.

In the case of trees,
no one can guarantee which wire their branches might touch.

If a tree were to brush up against the top wire in the circuit,
it would make the top wire safe to touch
and the bottom one dangerous –
just the opposite of the previous scenario where the tree contacts
the bottom wire:

In a simple two-wire electrical power system, the conductor connected to ground is called the *neutral*, and the other conductor is called the *hot*, also known as the *live* or the *active*:

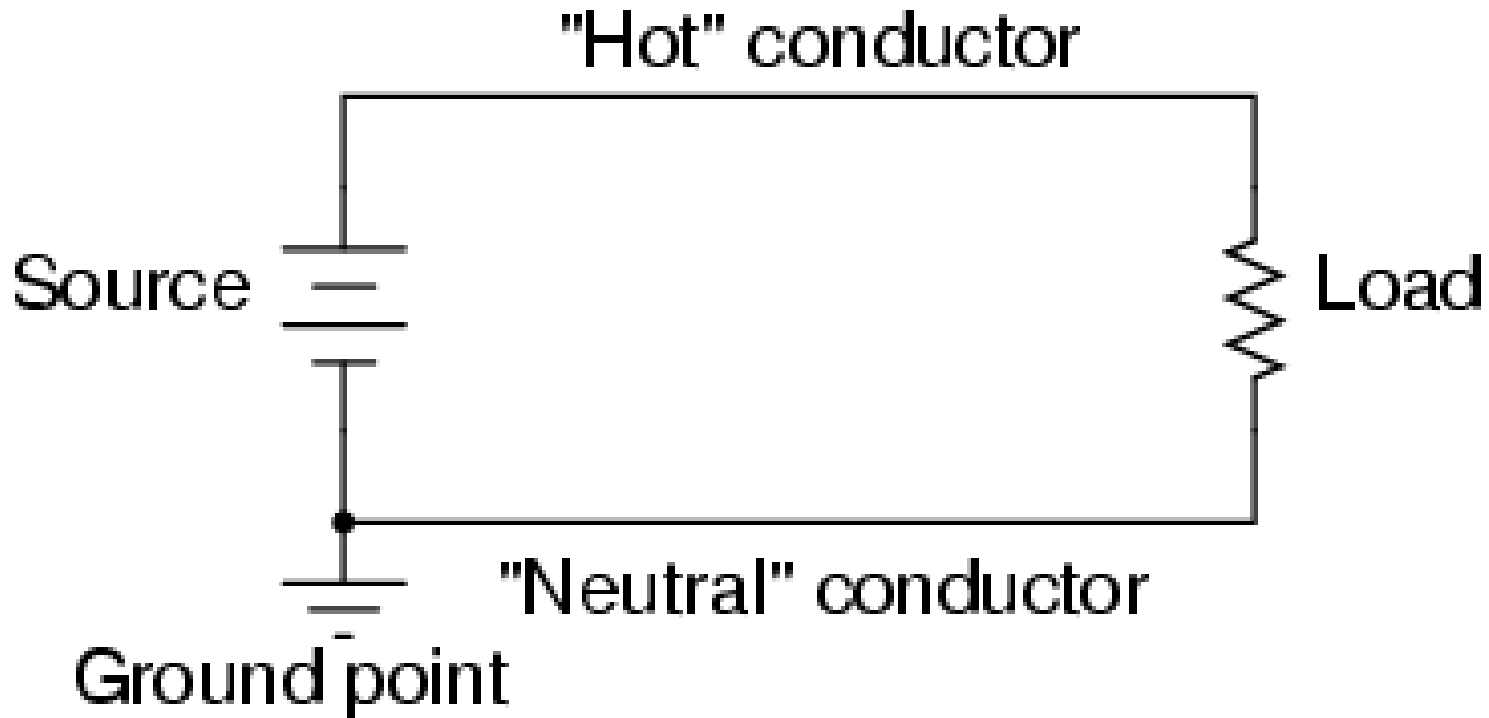

As far as the voltage source and load are concerned,
grounding makes no difference at all.

It exists purely for the sake of personnel safety,
by guaranteeing that at least one point in the circuit
will be safe to touch (zero voltage to ground).

The "Hot" side of the circuit,
named for its potential for shock hazard,
will be dangerous to touch unless voltage
is secured by proper disconnection
from the source

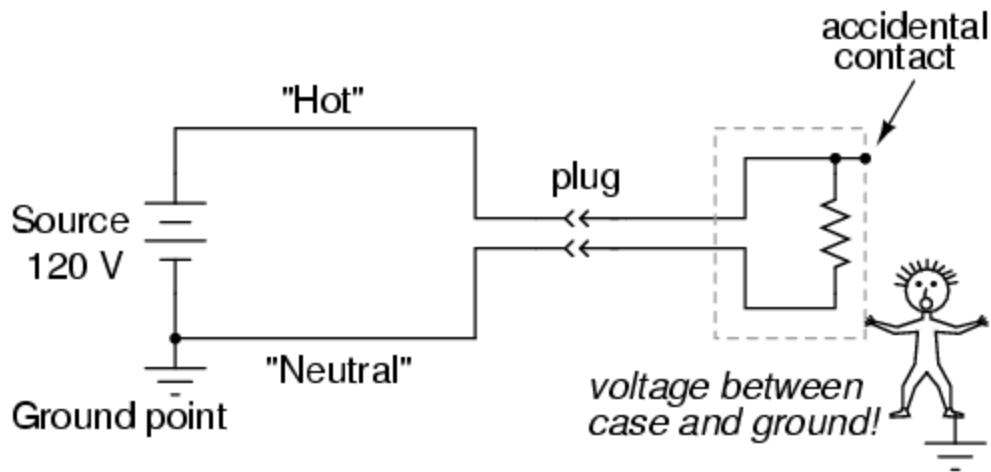
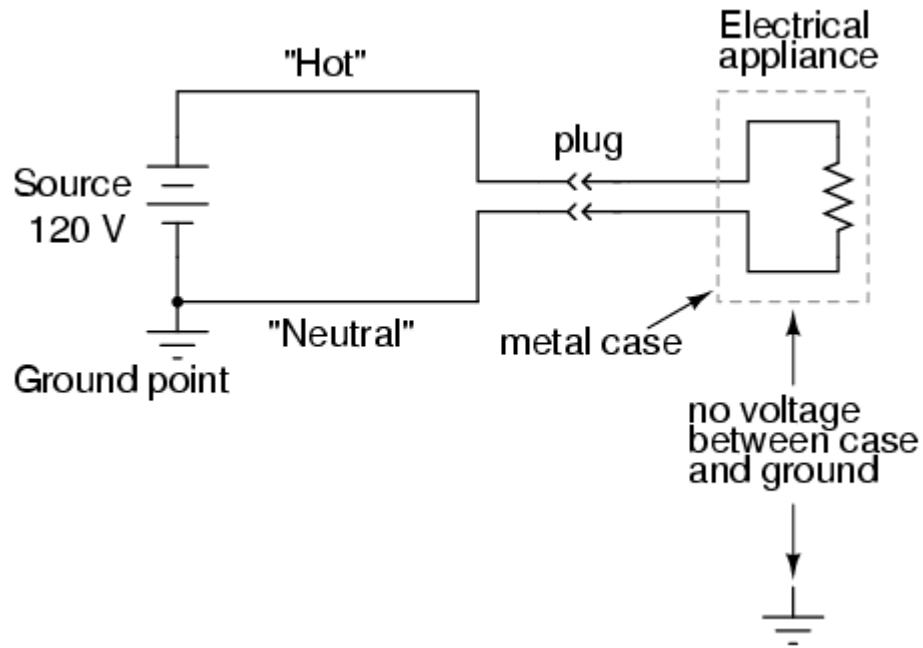

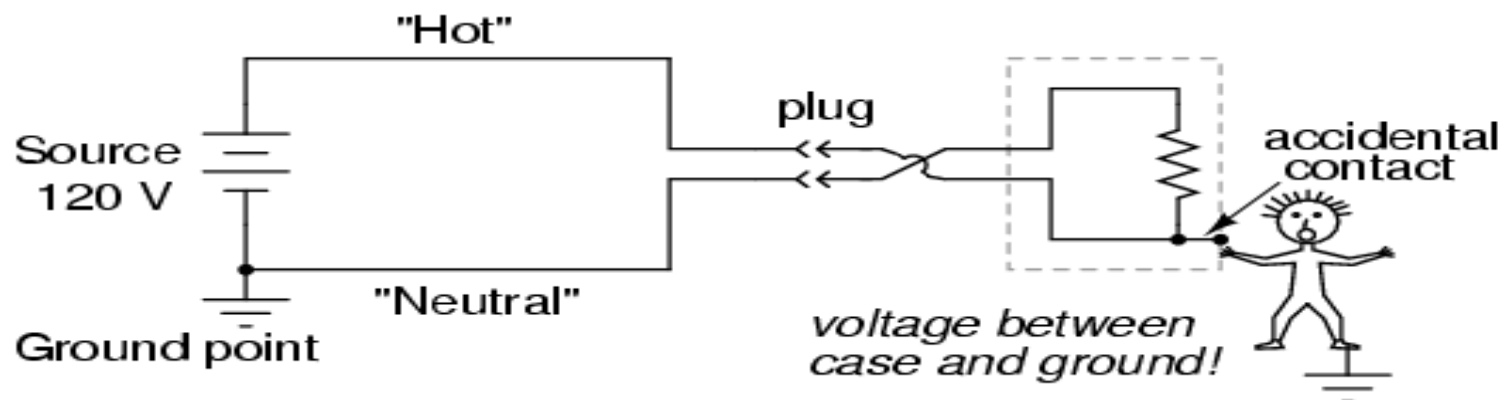
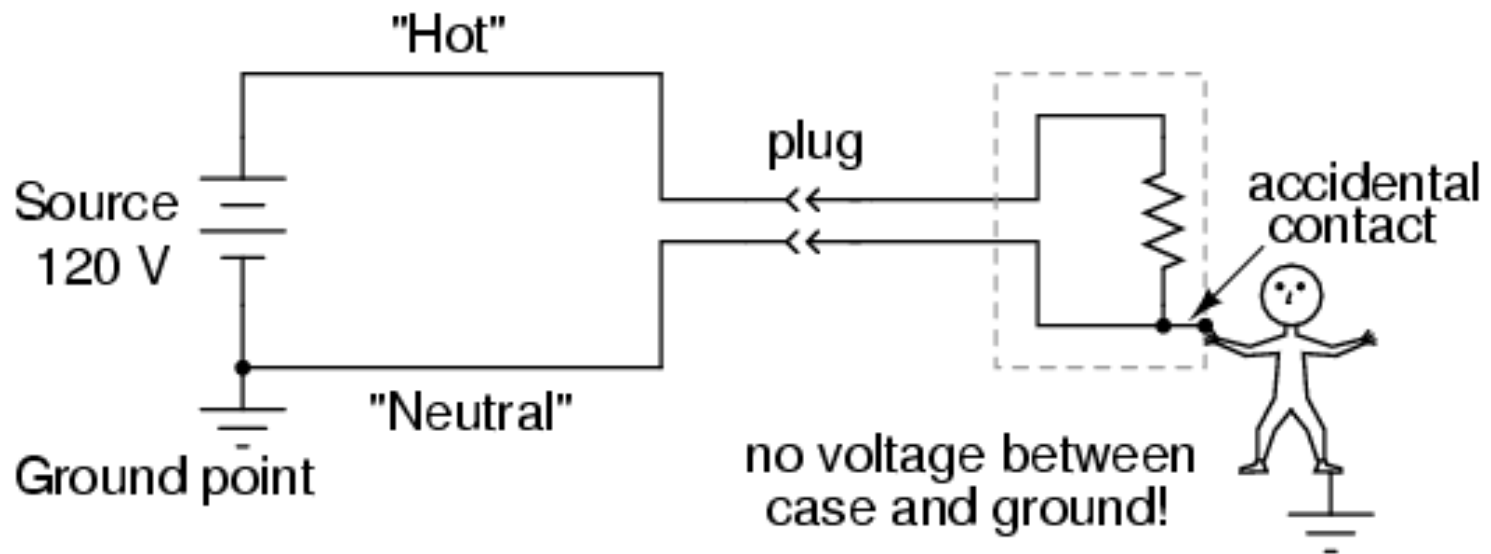

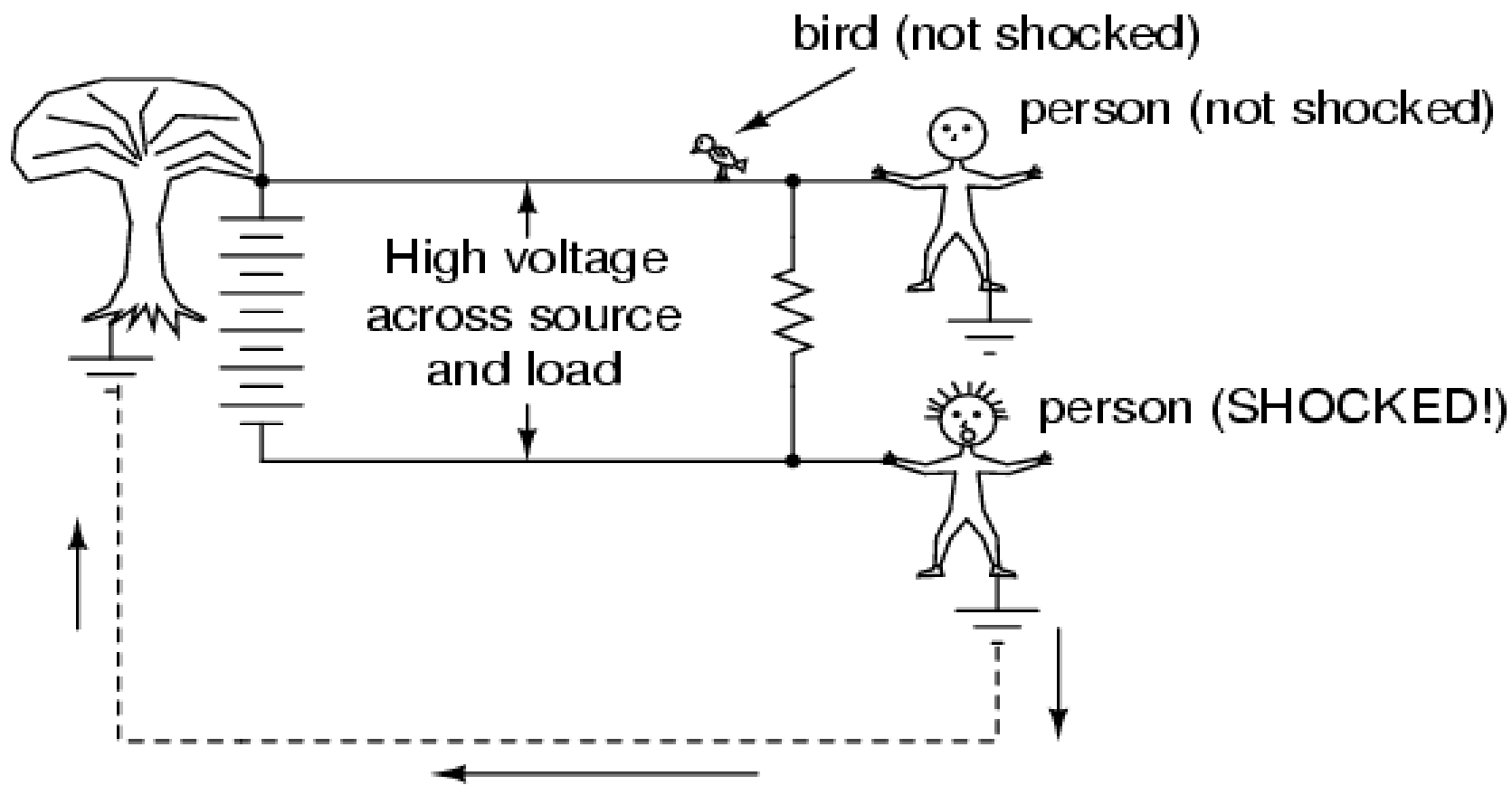

accidental ground path through tree (touching wire) completes the circuit for shock current through the victim.

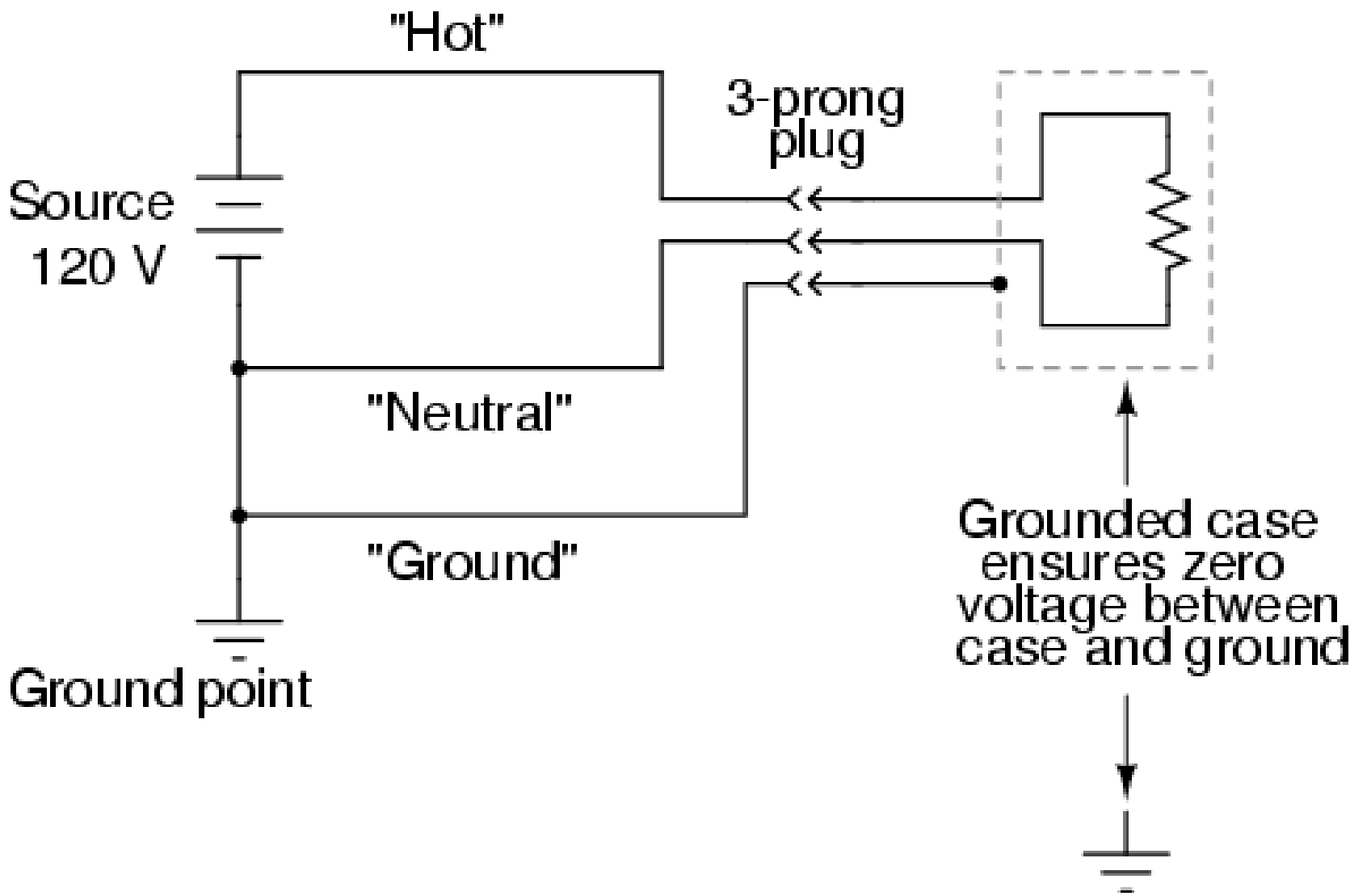

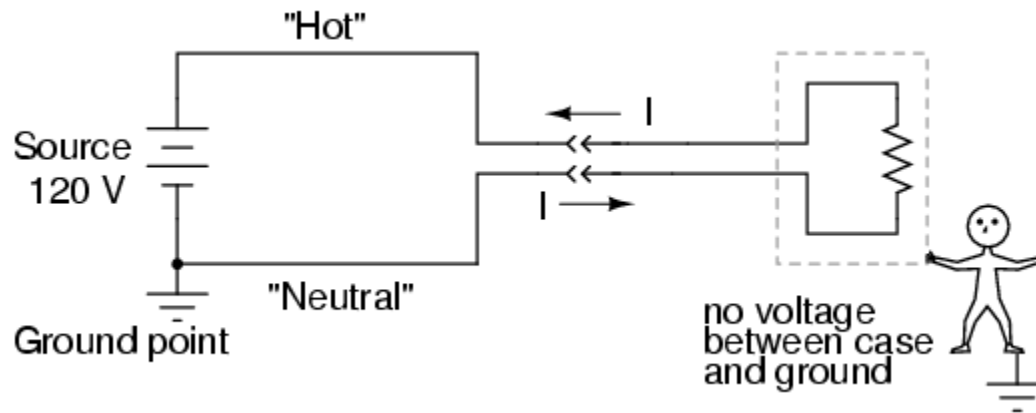

the current measured through the hot conductor should be exactly equal to the current through the neutral conductor, because there's only one path for electrons to flow in the circuit. With no fault inside the appliance, there is no connection between circuit conductors and the person touching the case, and therefore no shock.

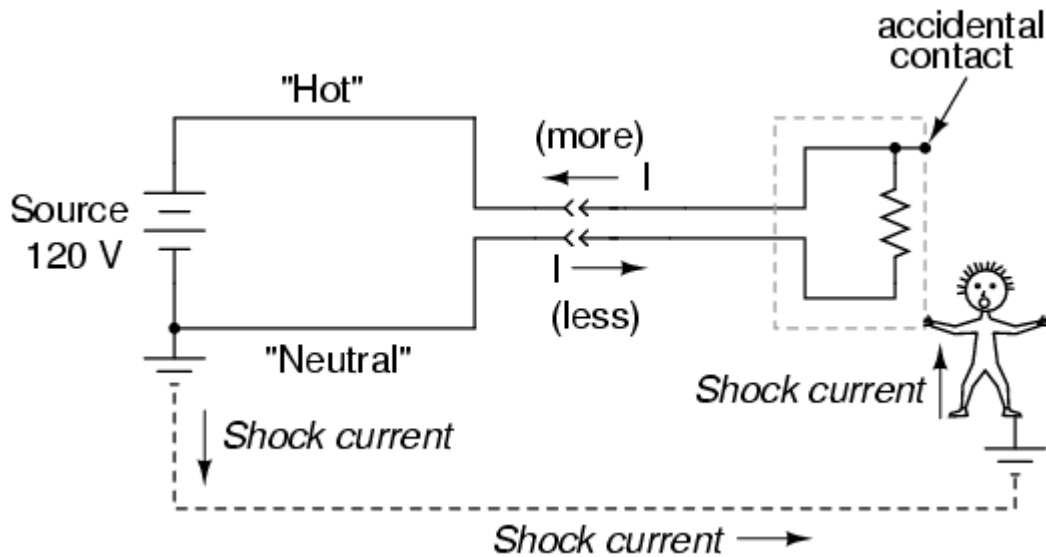

the hot wire accidentally contacts the metal case, there will be current through the person touching the case.

The presence of a shock current will be manifested as a difference of current between the two power conductors at the receptacle:

difference in current between
the "hot" and "neutral" conductors
will only exist
if there is current through the ground connection,
meaning that there is a fault in the system.

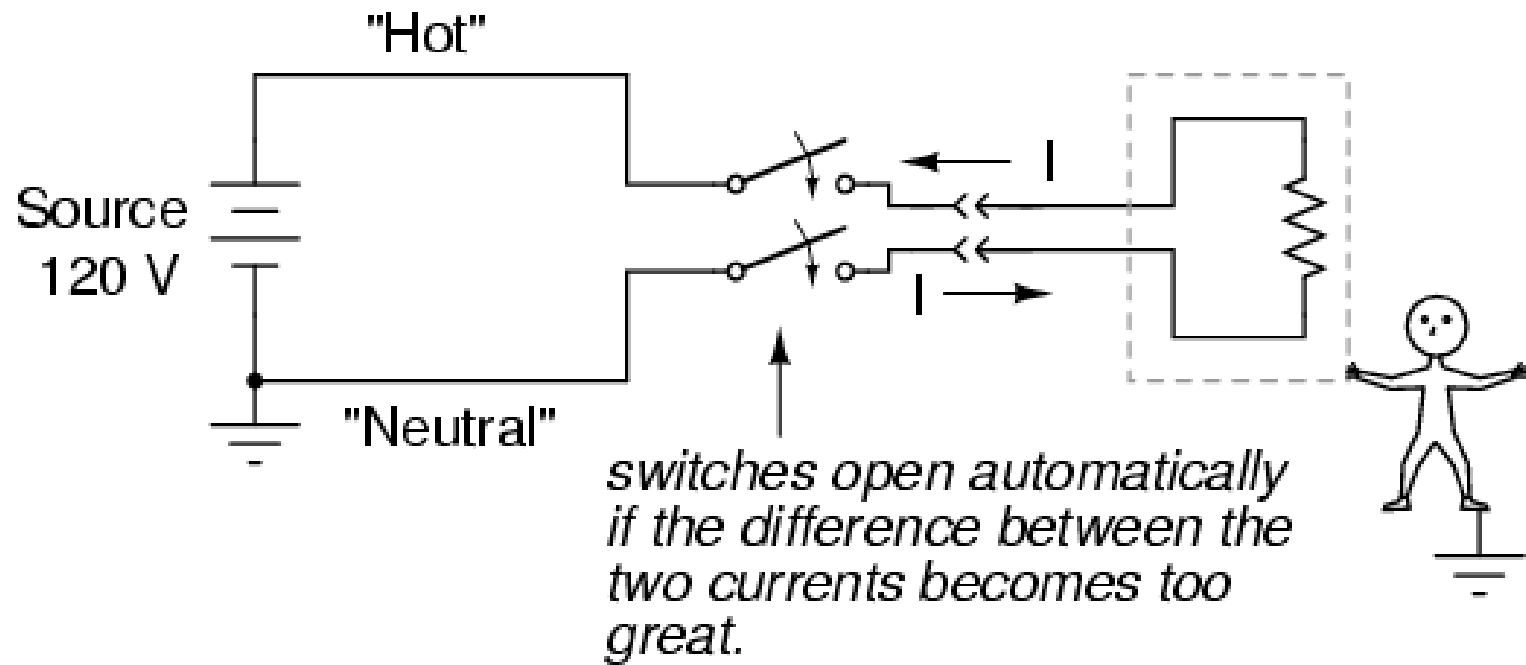

Ground Fault Current Interruptors,
or
GFCIs

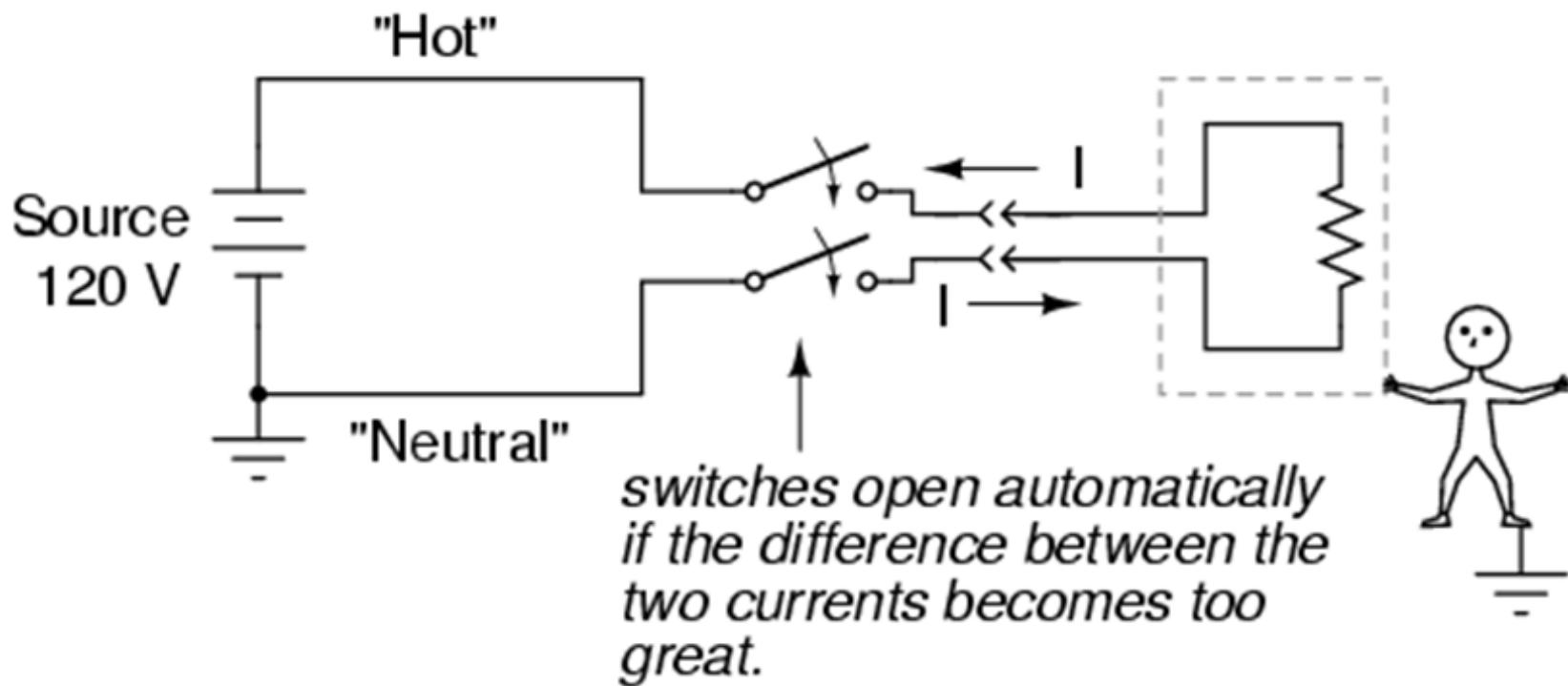

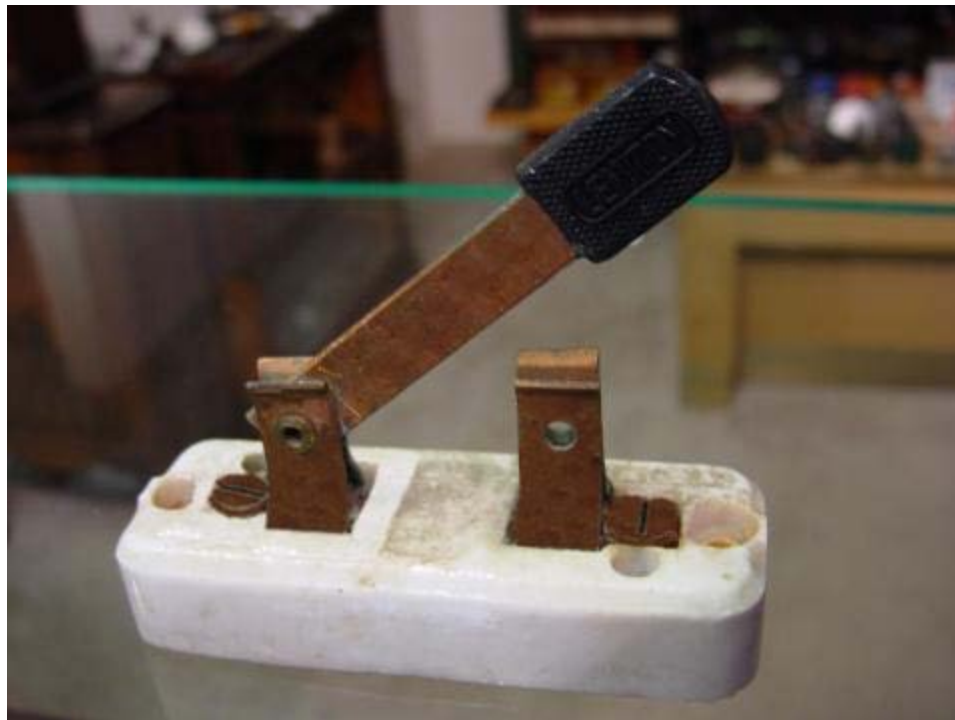
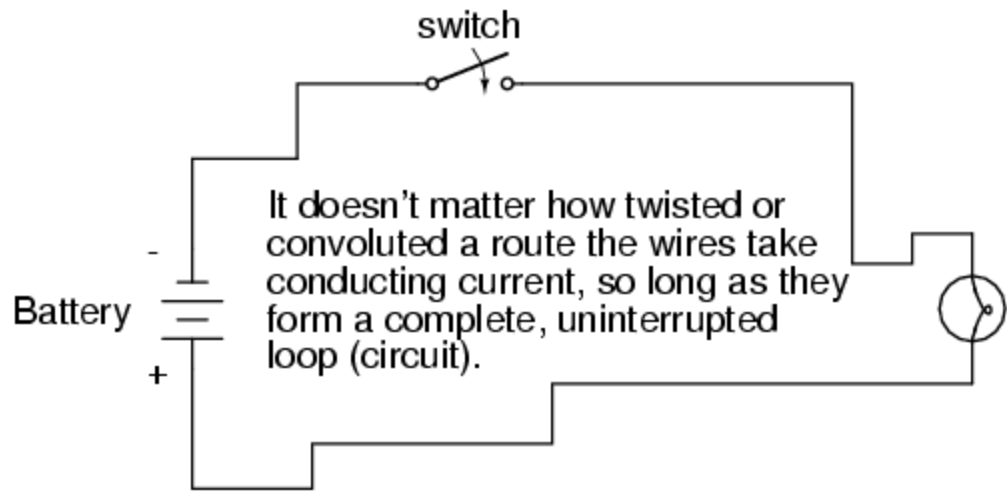

What is

a

SERIES

PARALLEL

CIRCUIT?

Series Circuit

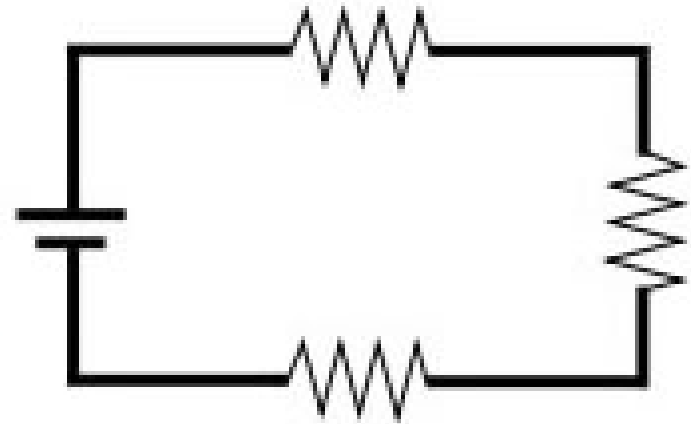
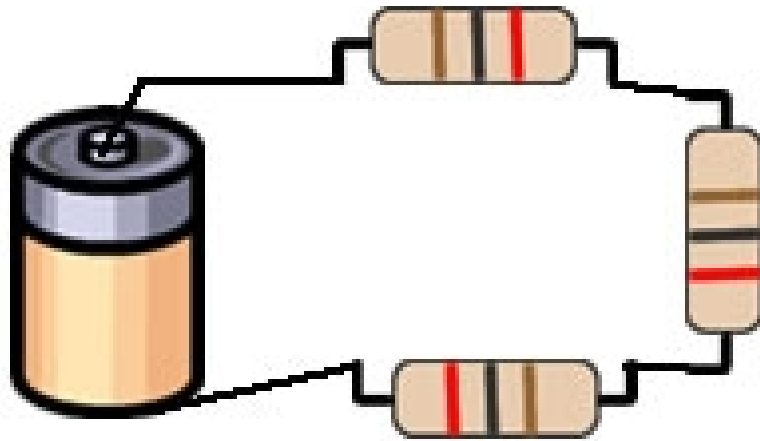

parallel circuit

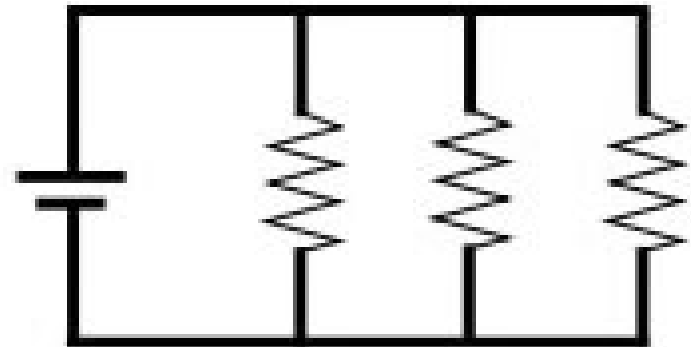
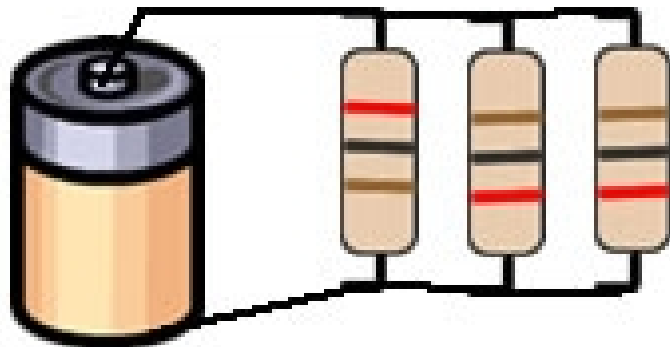

With simple **series circuits,**

all components are connected end-to-end

to form only one path for electrons to flow through the circuit:

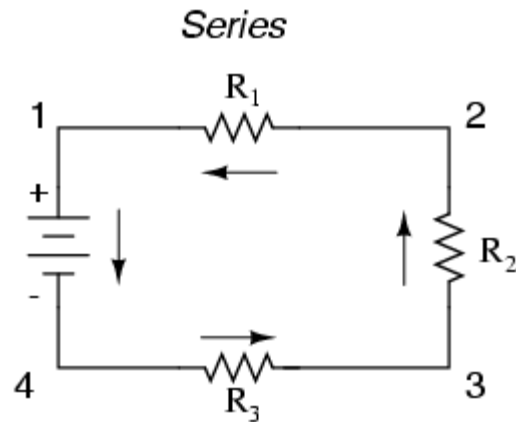

With simple **parallel circuits**,

all components are **connected between the same two sets of electrically common points,**

creating multiple paths for electrons to flow from one end of the battery to the other:

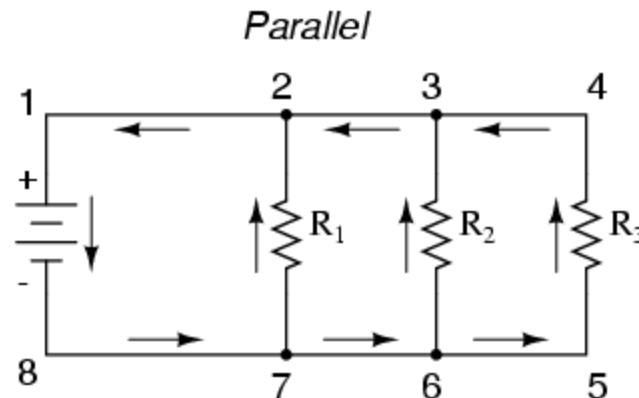

Series Circuits:

- Voltage drops add to equal total voltage.
- All components share the same (equal) current.
- Resistances add to equal total resistance.

•Parallel Circuits:

- All components share the same (equal) voltage.
- Branch currents add to equal total current.
- Resistances diminish to equal total resistance.

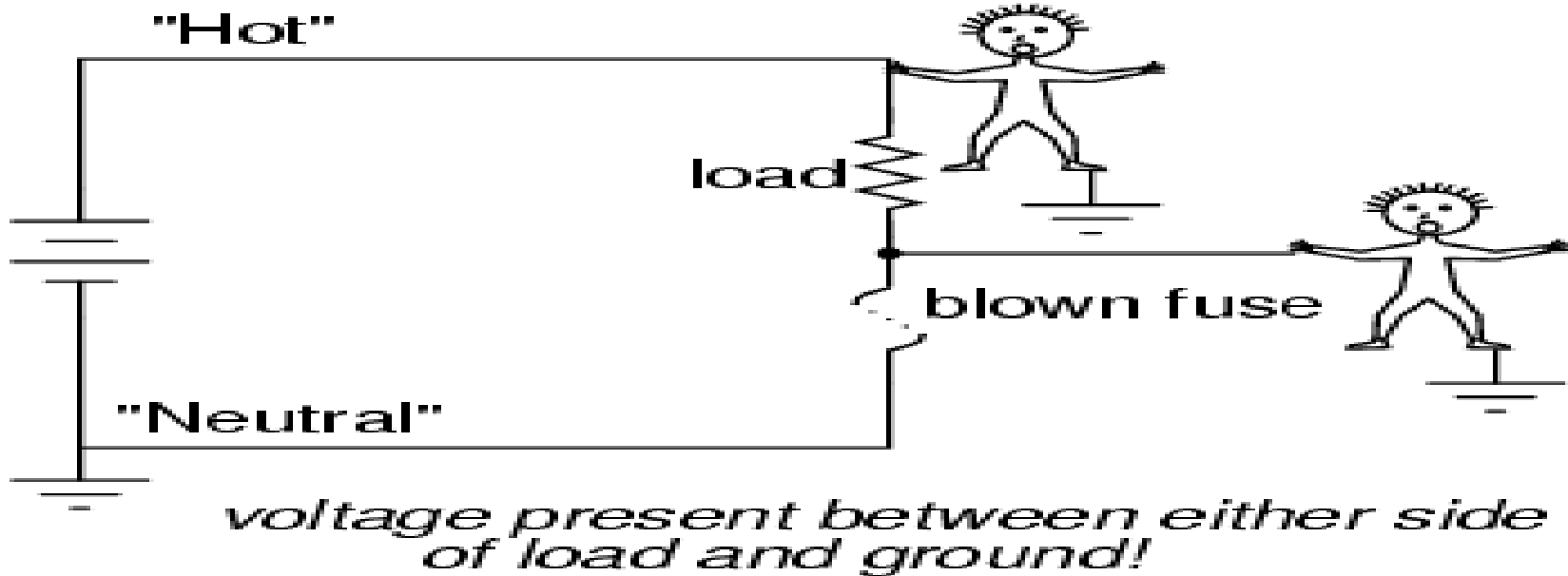
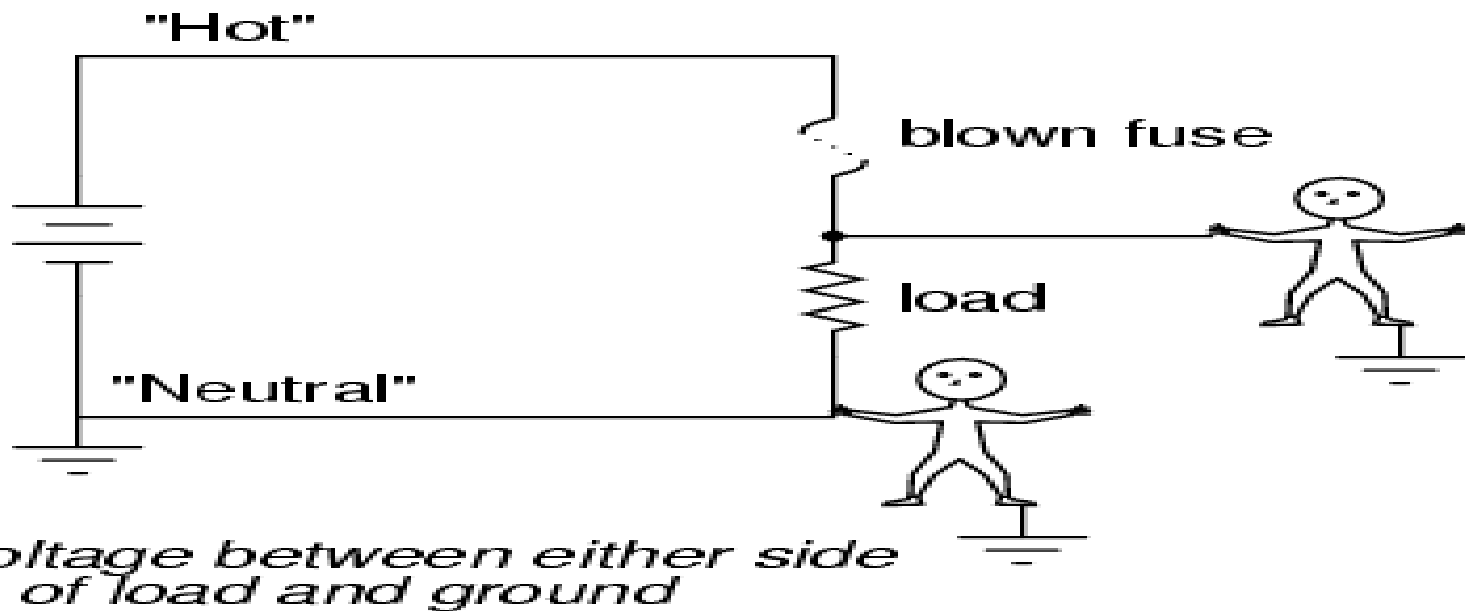



Glass cartridge type fuses



Screw-in type fuse

Relay

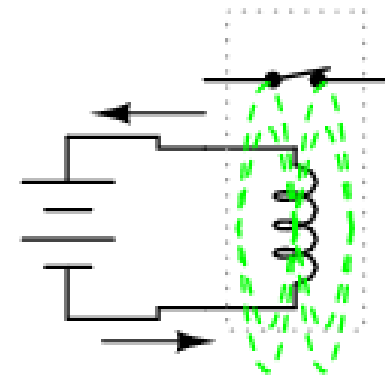
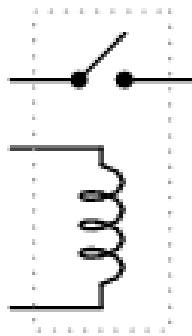

Applying current through the coil causes the switch to close.

*Multiple-contact
relay*

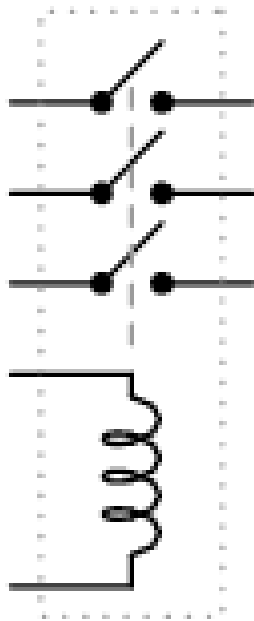

*Relay with "normally-
closed" contact*

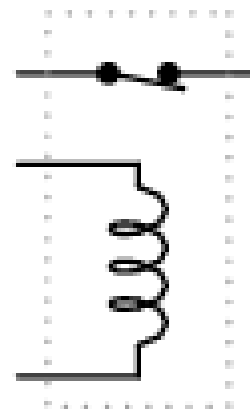





Ohm's Law

	Resistance	Current	Voltage
Definition	The opposition to the flow of charges	The flow of electrons through a circuit	Potential Difference (the push behind electricity)
Symbol	R	I	V
Equation	$R = \frac{V}{I}$	$I = \frac{V}{R}$	$V = I R$

Resistance

Current

Voltage

Label	Ω - Omega symbol	A - amperes	V - volts
Depends on	<p>The size of the wire.</p> <p>Thick wire – Less resistance </p> <p>Thin wire – More resistance </p> <p>Long wire – more resistance </p> <p>Short wire- less resistance </p>	<p>The resistance in the circuit</p> <p>Greater resistance- less current</p> <p>Less resistance the greater the current</p>	<p>The voltage source</p> <p>Greater Potential difference = greater voltage</p>

Resistance

Current

Voltage

Label	Ω - Omega symbol	A - amperes	V - volts
-------	-------------------------	-------------	-----------

Two symbols same meaning

	Resistance	Current	Voltage
Definition	The opposition to the flow of charges	The flow of electrons through a circuit	Potential Difference (the push behind electricity)
Symbol	R	I	V
Equation	$R = \frac{V}{I}$	$I = \frac{V}{R}$	$V = I R$

To obey Ohm's law means a conductor has a constant resistance regardless of the voltage.

- If you know two of the three variables you should be able to solve for the third.
- When using Ohm's law always use the 3 step form
 - 1. Write the equation
 - 2. Replace the known values
 - 3. Solve the problem
 - . Label with the correct unit of measurement.

Practice problems

In a circuit, 0.5 A is flowing through the bulb. The voltage across the bulb is 4.0 V. What is the bulb's resistance?

1. Write the equation

$$R = \frac{V}{I}$$

2. Replace the known values

$$R = \frac{4.0}{0.5}$$

3. Solve

$$R = 8$$

4. Label

$$R = 8 \, \Omega$$

Practice problem

- You light a light bulb with a 1.5 volt battery. If the bulb has a resistance of 10 ohms, how much current is flowing?

- Write the equation $I = \frac{V}{R}$
- Replace the known values $I = \frac{1.5}{10}$
- Solve $I = 0.15$
- Label correct sig.fig $I = 0.2 \text{ A}$

Quantity	Symbol	Unit of Measurement	Unit Abbreviation
Current	I	Ampere ("Amp")	A
Voltage	E or V	Volt	V
Resistance	R	Ohm	Ω

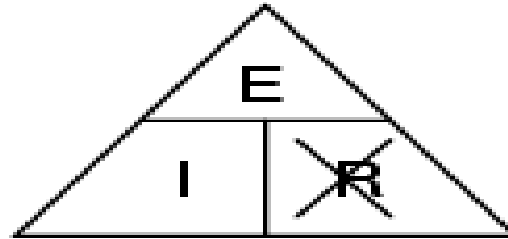
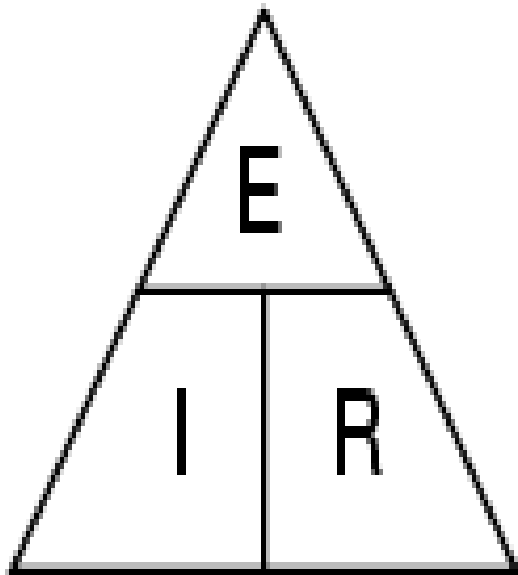

$$R = \frac{E}{I}$$

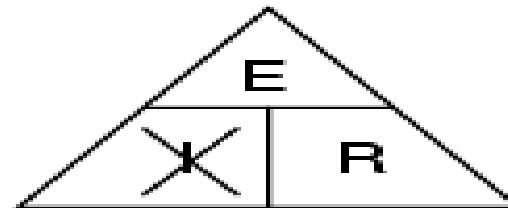

$$I = \frac{E}{R}$$

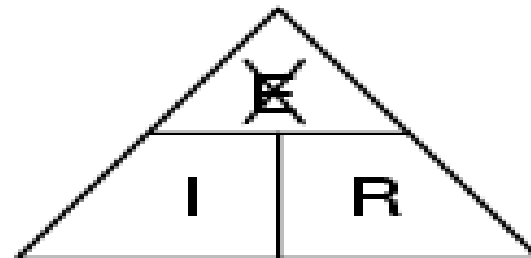

$$E = I R$$

$$I = \frac{E}{R}$$

$$R = \frac{E}{I}$$

What is the amount of current (I) in this circuit?

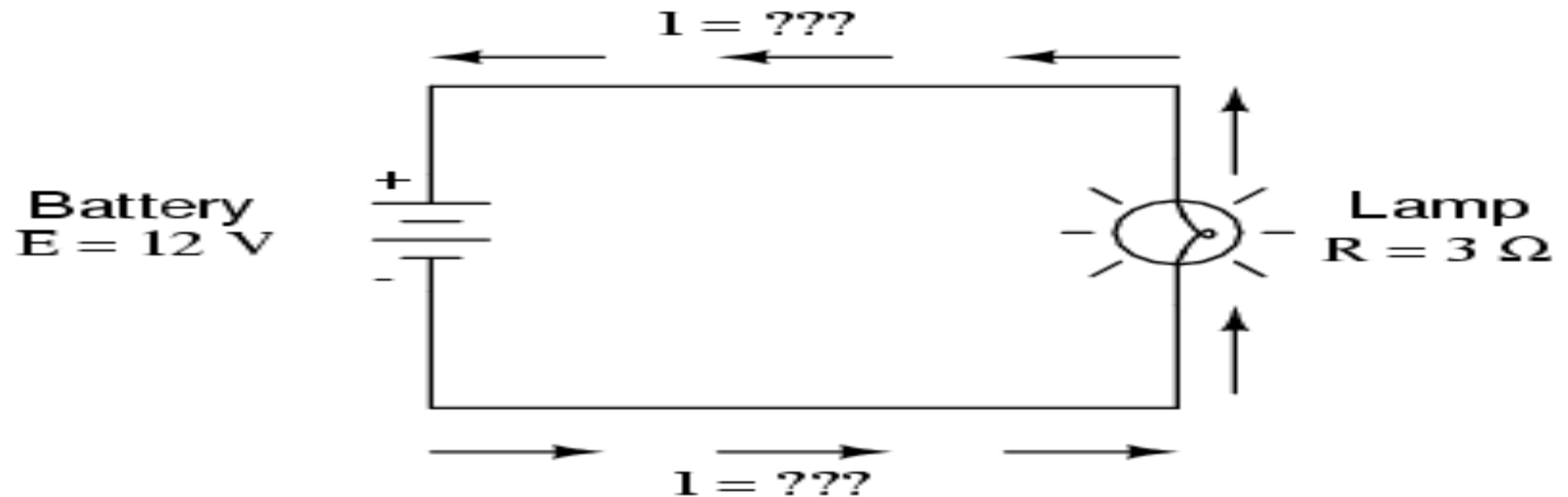

$$I = \frac{E}{R} = \frac{12 \text{ V}}{3 \Omega} = 4 \text{ A}$$

$$I = \frac{E}{R}$$

$$R = \frac{E}{I}$$

What is the amount of resistance (R) offered by the lamp?

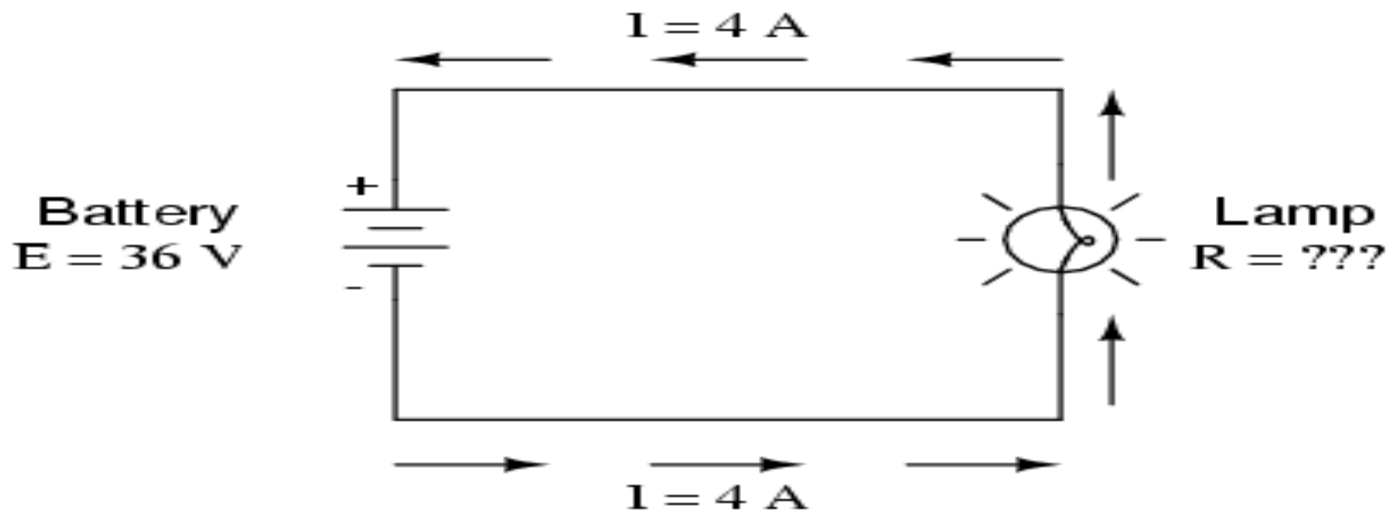

$$R = \frac{E}{I} = \frac{36 \text{ V}}{4 \text{ A}} = 9 \Omega$$

calculate the amount of voltage supplied by a battery,
given values of current (I) and resistance (R):

What is the amount of voltage provided by the battery?

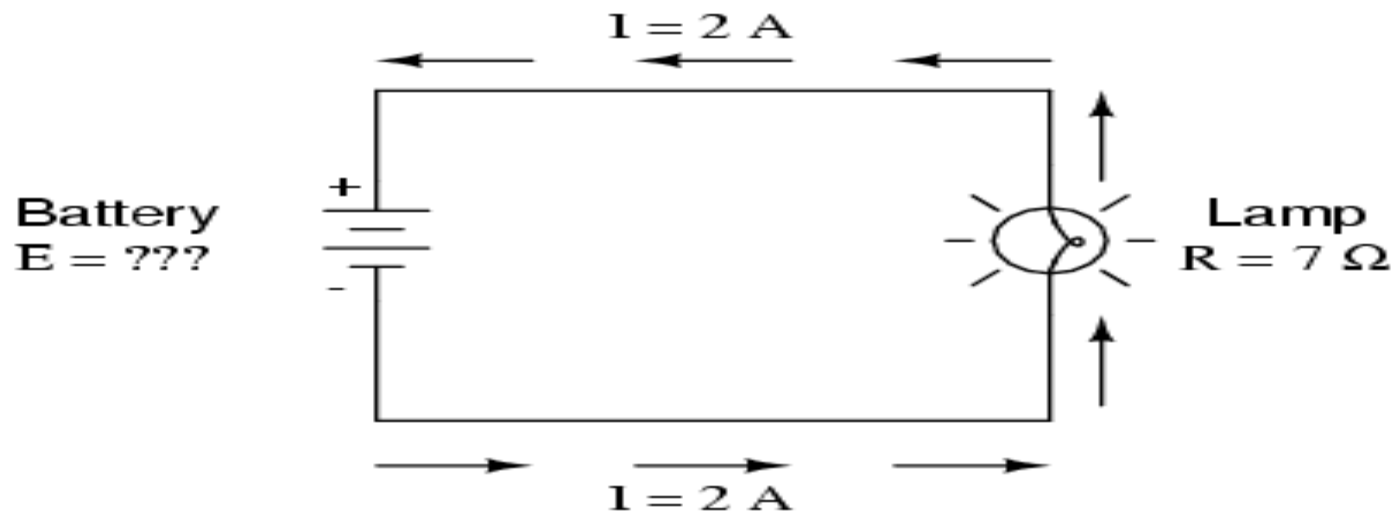

$$E = IR = (2 \text{ A})(7 \text{ } \Omega) = 14 \text{ V}$$

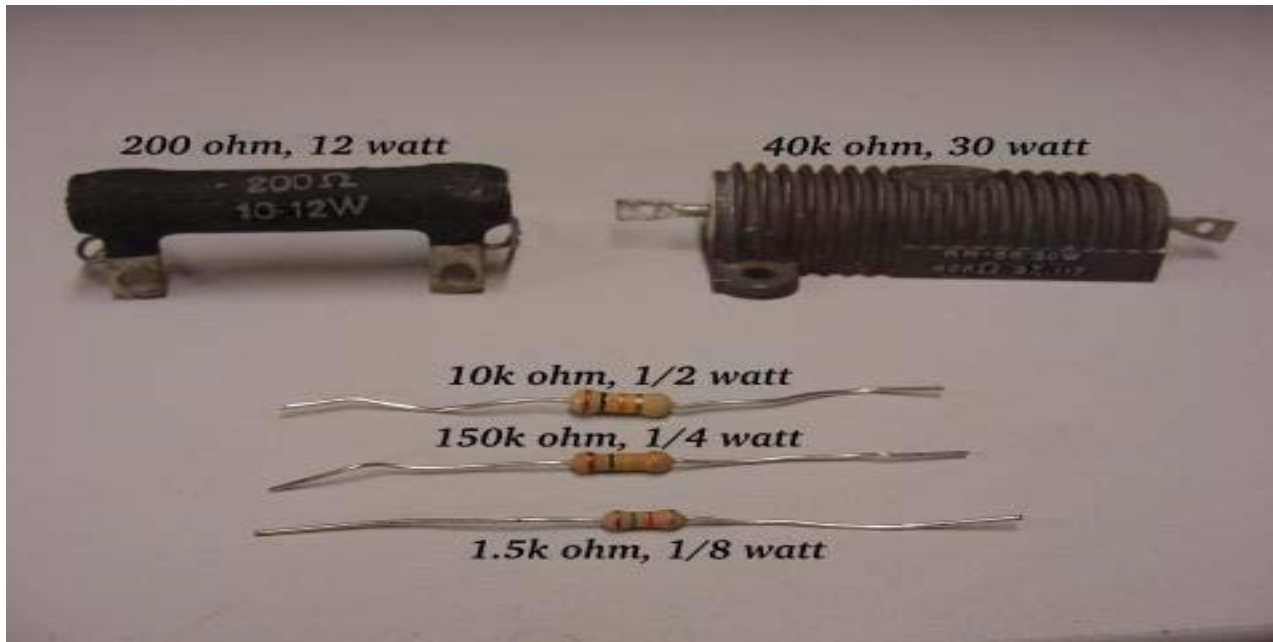

schematic symbol for a resistor looks like a small, rectangular box:

component symbol drawn with a diagonal arrow through it, that component has a variable rather than a fixed value. This symbol "modifier" (the diagonal arrow) is standard electronic symbol convention.

*variable
resistance*



... or ...

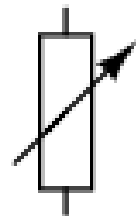



potentiometers

Variable resistors must have some physical means of adjustment, either a rotating shaft or lever that can be moved to vary the amount of electrical resistance.

ground

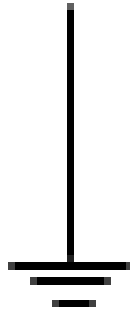

A connection to earth. Used for zero potential reference and electrical shock protection.

chassis



Connected to the chassis of the circuit.

battery

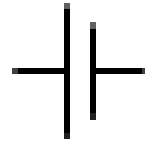

Supplies electrical energy. A battery is more than one cell.

capacitor

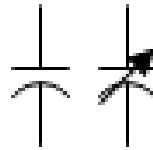
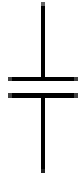

A capacitor stores electric charge. A capacitor is used with a resistor in a timing circuit.

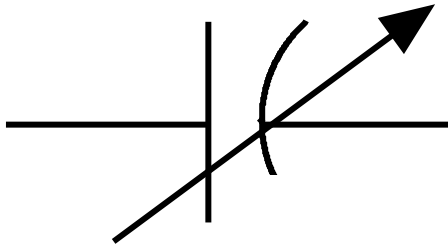

capacitor

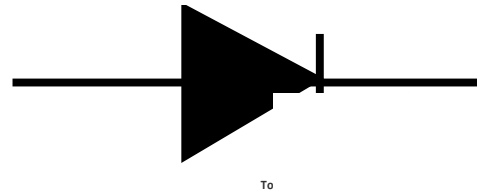

diode



Made with a Trial
Copy of SmartDraw

To remove this watermark, please purchase SmartDraw
at www.smartdraw.com or call 1-800-768-3729



Made with a Trial
Copy of SmartDraw

To remove this watermark, please purchase SmartDraw
at www.smartdraw.com or call 1-800-768-3729

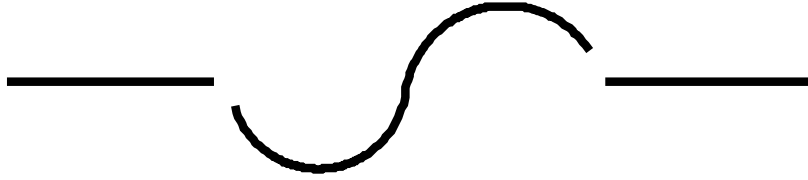

fuse



Make on close NO

Made with a Trial
Copy of SmartDraw

To remove this watermark, please purchase SmartDraw
at www.smartdraw.com or call 1-800-768-3729



Made with a Trial
Copy of SmartDraw

To remove this watermark, please purchase SmartDraw
at www.smartdraw.com or call 1-800-768-3729

Brake on open NC

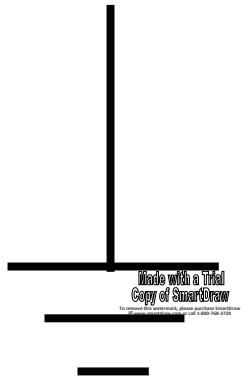

Earth ground

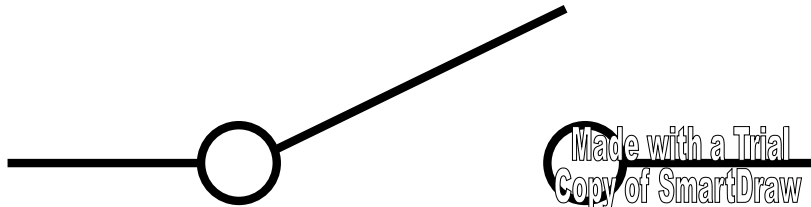

Single pole switch



Single pole switch
double throw

Made with a Trial
Copy of SmartDraw
To remove this watermark, please purchase SmartDraw
at www.smartdraw.com or call 1-800-768-3729

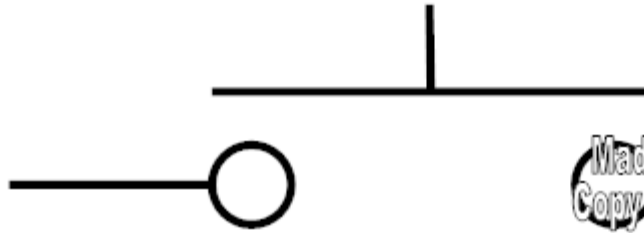

Made with a Trial
Copy of SmartDraw

To remove this watermark, please purchase SmartDraw
at www.smartdraw.com or call 1-800-768-3729

Push button

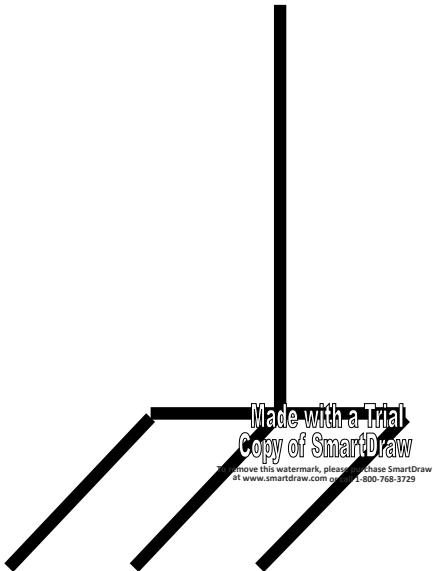

Made with a Trial
Copy of SmartDraw

To remove this watermark, please purchase SmartDraw
at www.smartdraw.com or call 1-800-768-3729

Chassis ground

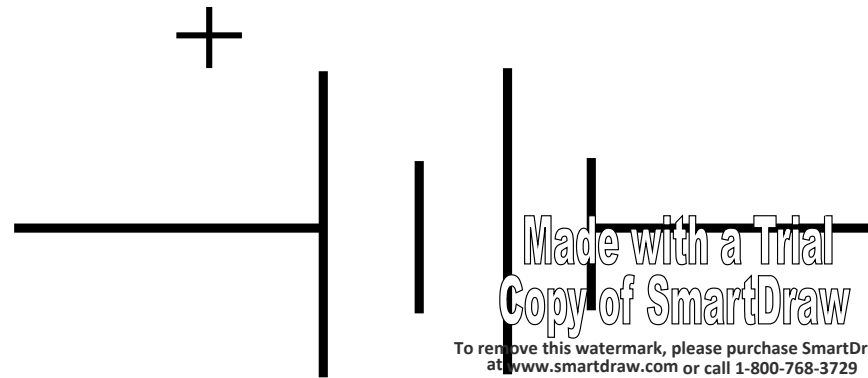

Made with a Trial
Copy of SmartDraw

To remove this watermark, please purchase SmartDraw
at www.smartdraw.com or call 1-800-768-3729

battery

circuit breaker



A circuit breaker is an automatically operated electrical switch designed to protect an electrical circuit from damage caused by overload or short circuit.

fuse



A type of sacrificial overcurrent protection device.

 switch (open)

 switch (closed)

 cell

 battery

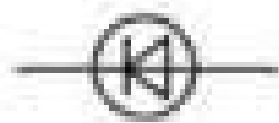
 diode

 resistor

 variable resistor

 lamp

 fuse

 voltmeter

 ammeter

 thermistor

 LDR

Transformer

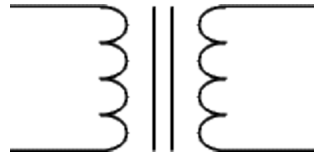

Two coils of wire linked by an iron core. Transformers are used to step up (increase) and step down (decrease) AC voltages. Energy is transferred between the coils by the magnetic field in the core. There is no electrical connection between the coils.

Earth (Ground)

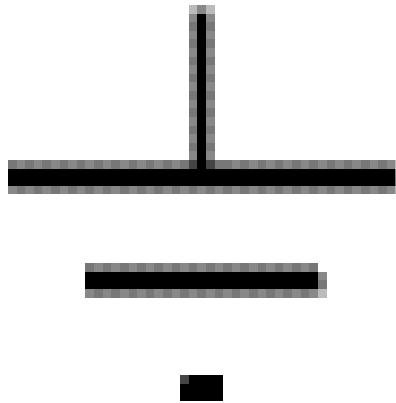

A connection to earth. For many electronic circuits this is the 0V (zero volts) of the power supply, but for mains electricity and some radio circuits it really means the earth. It is also known as ground.

Fuse

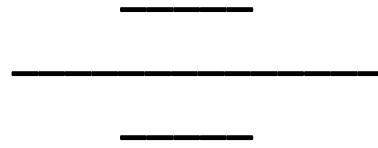

A safety device which will 'blow' (melt) if the current flowing through it exceeds a specified value.

Resistor

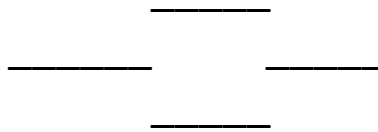

A resistor restricts the flow of current, for example to limit the current passing through an LED. A resistor is used with a capacitor in a timing circuit.

Some publications still use the old resistor symbol:

Variable Resistor (Rheostat)

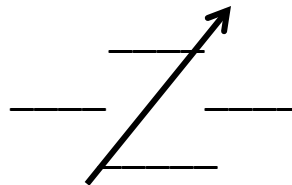

This type of variable resistor with 2 contacts (a rheostat) is usually used to control current. Examples include: adjusting lamp brightness, adjusting motor speed, and adjusting the rate of flow of charge into a capacitor in a timing circuit.

Diode

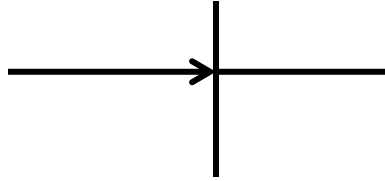

A device which only allows current to flow in one direction.

Inductor (Coil, Solenoid)



A coil of wire which creates a magnetic field when current passes through it. It may have an iron core inside the coil. It can be used as a transducer converting electrical energy to mechanical energy by pulling on something.

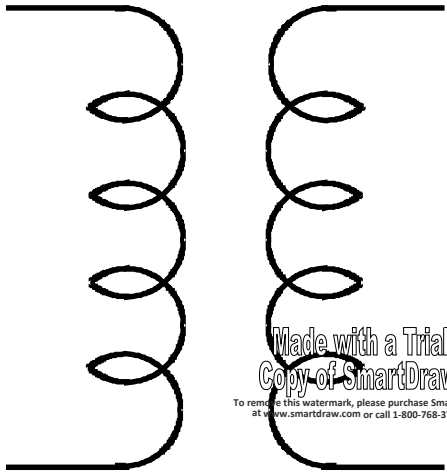

Made with a Trial Copy of SmartDraw
To remove this watermark, please purchase SmartDraw at www.smartdraw.com or call 1-800-768-3729

transformer

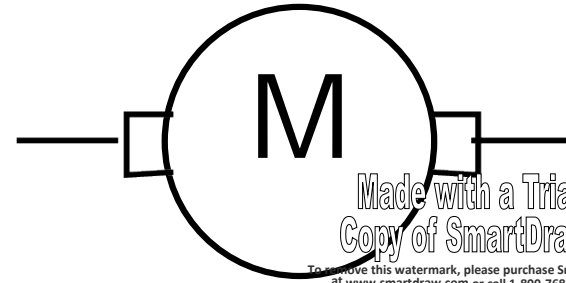

Made with a Trial Copy of SmartDraw
To remove this watermark, please purchase SmartDraw at www.smartdraw.com or call 1-800-768-3729

motor

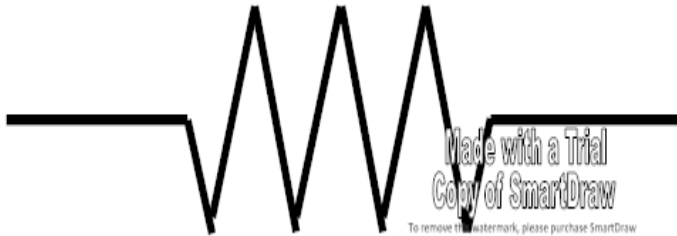

Made with a Trial Copy of SmartDraw
To remove this watermark, please purchase SmartDraw at www.smartdraw.com or call 1-800-768-3729

resistor

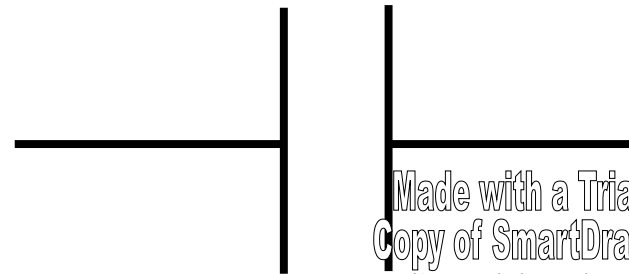

Made with a Trial Copy of SmartDraw
To remove this watermark, please purchase SmartDraw at www.smartdraw.com or call 1-800-768-3729

capacitor

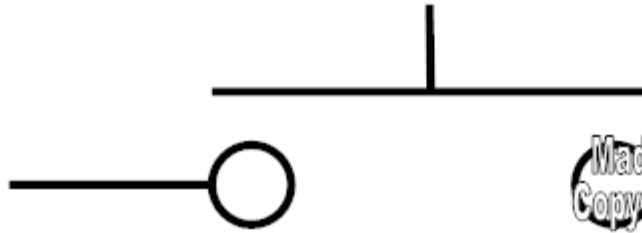

Made with a Trial
Copy of SmartDraw

To remove this watermark, please purchase SmartDraw
at www.smartdraw.com or call 1-800-768-3729

Push button

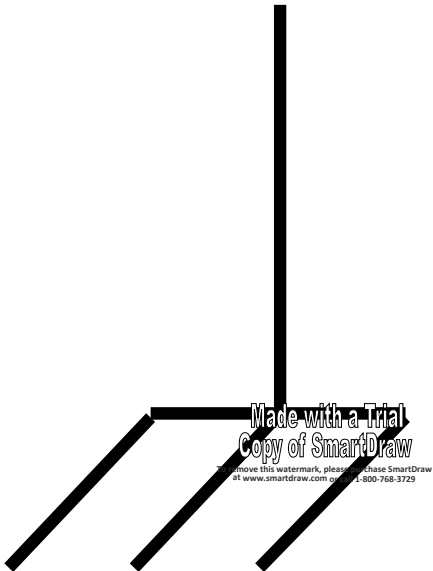

Made with a Trial
Copy of SmartDraw

To remove this watermark, please purchase SmartDraw
at www.smartdraw.com or call 1-800-768-3729

Chassis ground

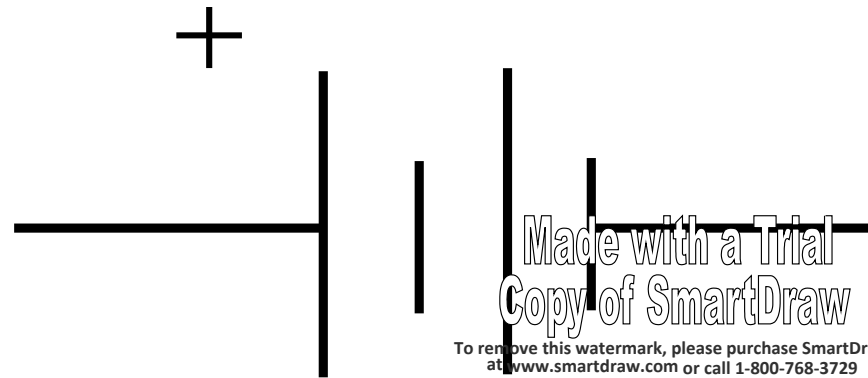

Made with a Trial
Copy of SmartDraw

To remove this watermark, please purchase SmartDraw
at www.smartdraw.com or call 1-800-768-3729

battery

Article 525 of the National Electrical Code covers the installation of portable wiring and equipment for carnivals, circuses, exhibitions, fairs, traveling attractions, and similar functions, including wiring in or on all structures.

If you use electric motors to circulate water in a tank that guests might touch,

Article 680 applies.

A key provision: 680.22(A)(1) permits a GFCI-protected single locking-type receptacle for a water-pump motor between 5 feet and 10 feet from the water

Overhead conductor clearances

Overhead conductors
must have a clearance of 15 feet
from amusement rides and attractions
(except, of course, for the conductors that supply power to the
ride or attraction) [525.5(B)].

For overhead conductors installed outside tents and concession areas, the vertical clearance requirements of 225.18 apply [525.5(A)].

The minimums are:

- 10 feet above finished grade, sidewalks, platforms, or projections from which they might be accessible to pedestrians for 120V, 120/208V, 120/240V, or 240V circuits.



12 feet

above residential property and driveways,

and those commercial areas not subject to truck traffic
for 120V, 120/208V, 120/240V, 240V, 277V, 277/480V, or 480V
circuits.



18 feet

over public streets, alleys, roads, parking areas subject to truck traffic,

driveways on other than residential property,
and other areas traversed by vehicles

(such as those used for cultivation, grazing, forestry, and orchards).

525.21 Disconnecting Means.

A means to disconnect each portable structure from all ungrounded conductors shall be provided.

The switch shall consist of no more than six enclosed switches or circuit breakers and shall be located within sight of and within 6 feet of the operator's station.

525.20 **Portable Cords.**

Portable cords shall be size 12 or larger
Type G, PPE, S, SE, SEO, SEOO, SC, SCE, SCT, SO, SOO, ST, STO,
STOO, W

or other types identified for extra-hard usage,
and must be of the grounding type.

The cord type is printed or embossed on approved cords.

Two-wire cords are not allowed.

Cables with a "J" in the type designation (such as Type SJT) are junior-hard-
service rated

and are not permitted where subject to physical damage.

When used outdoors, cords shall be listed for wet locations and be sunlight
resistant,

unless they are an integral part of listed portable equipment.



All cords shall be continuous and contain no splices.

Repair of the cord outer jacket only may be done

with heavy-wall heat-shrink tubing with proper adhesive or by a vulcanizing process.



240.20 & 240.22 **Overcurrent Protective Devices.**
Motors and lighting circuits
shall have separate fuses or circuit breakers.

Lighting circuits shall be protected
at no more than 20 amperes.

Motors shall be protected
at not over 125% of full load current
or shall be thermally protected.

525.31 **Equipment Grounding.**

Equipment grounding conductors shall be run with all feeders and branch circuits.

Exposed metal parts of electrical equipment shall be bonded, and if cord connected, the cord shall have a grounding conductor and grounding type attachment plug.

Equipment that is listed and labeled as double insulated is permitted.

All grounding conductors in an enclosure shall terminate in a common grounding bus or lugs.

The equipment grounding bar or lug(s) shall be secured to the electrical enclosure with screws or bolts used for no other purpose.

Approved means shall be used to connect equipment grounding conductors to enclosures.

Equipment grounding conductors shall be isolated from grounded circuit conductors.

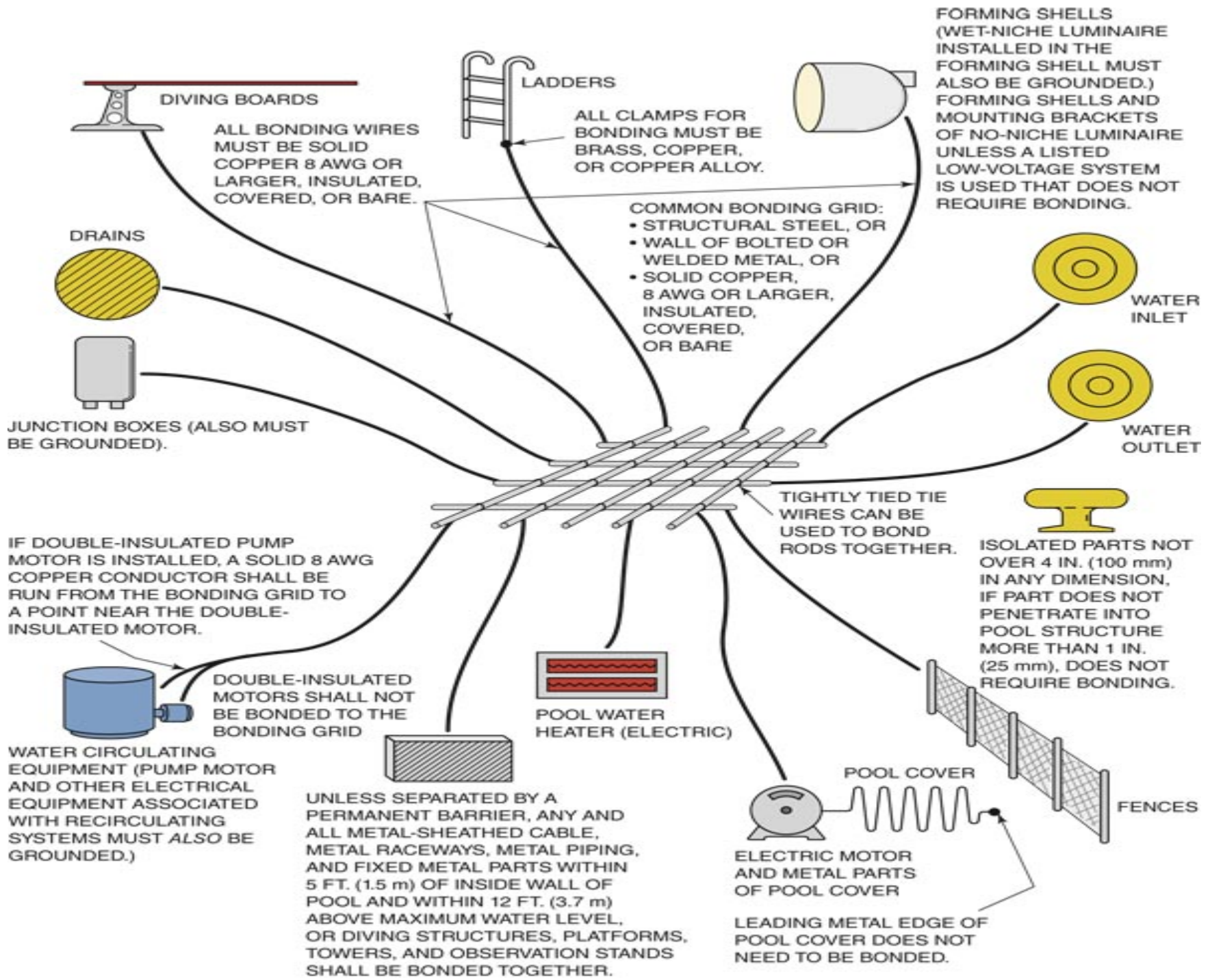

525.11 Multiple Sources of Supply.

Where multiple separately derived systems or services or both supply rides, games, attractions or other structures that are separated by less than 12 feet, all sources shall be bonded to the same grounding electrode system.

The bonding conductor shall be copper
and sized in accordance with Table 250.122
based on the
largest overcurrent device supplying the portable structures,

but not smaller than 6 AWG.

525.23 Ground-Fault Circuit-Interrupter Protection.

All 125-volt, single phase,
15- and 20-ampere receptacle outlets
that are in use by personnel
or readily accessible to the general public
shall have listed GFCI protection.

Manufactured cord sets
incorporating listed ground-fault circuit-interrupter protection
for personnel shall be permitted.

Egress lighting shall not be connected
to the load side
of a ground-fault circuit-interrupter device.

525.21 **Portable Wiring Inside Tents.**

Wiring for temporary lighting,
where installed inside tents and concessions,
shall be securely installed
and shall be protected from accidental breakage

**by a suitable fixture
or lamp-holder with a guard.**

**Overhead lighting
may be installed with approved Type SO cord sets.**

Festoon lighting
or cord sets shall be installed
at groundleast 10 feet above
where accessible to the public.

Carnivals, Circuses, and Fairs GFCI Protection Required 525.23(A)

2011
CC

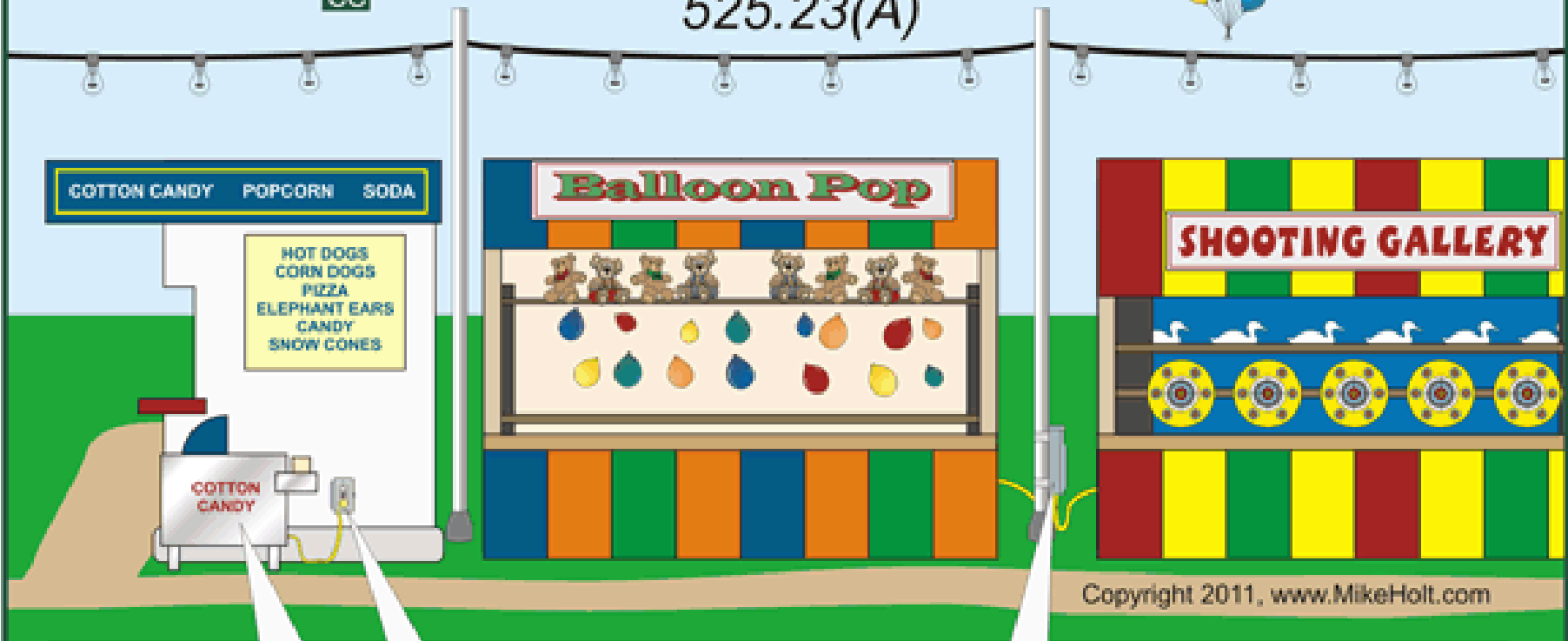

GFCI protection is required for:

- (1) 15A and 20A, 125V nonlocking-type receptacles used for disassembly and reassembly of amusement rides, or readily accessible to the general public.
- (2) Equipment readily accessible to the general public supplied with a 15A or 20A, 120V branch circuit.

525.5 **Overhead Clearances.**

A clearance of **15 feet**

in any direction shall be maintained
from overhead conductors operating **at 600 volts
or less and**

any portion of an amusement ride or attraction.

**No portion of an amusement ride or attraction
may be located under
or within 15 feet horizontally
of conductors operating
at over 600 volts.**

**Overhead conductors must have a 15 foot clearance
from amusements attractions**

Can not be located under or within 15 feet horizontally of conductors
of 600 volts or more.

Conductor must be 10 feet or above grade

Conductor must be 12 feet or above property and driveways
18 feet for public streets and areas

Overhead Conductor Clearances

- 10 ft above finished grade, sidewalks, platforms, or projections from which they might be accessible to pedestrians for 120V For overhead conductors installed outside tents and concession areas, the vertical clearance requirements of 225.18 apply [525.5(A)] (Figure 525-2). The minimums are:, 120/208V, 120/240V, or 240V circuits.

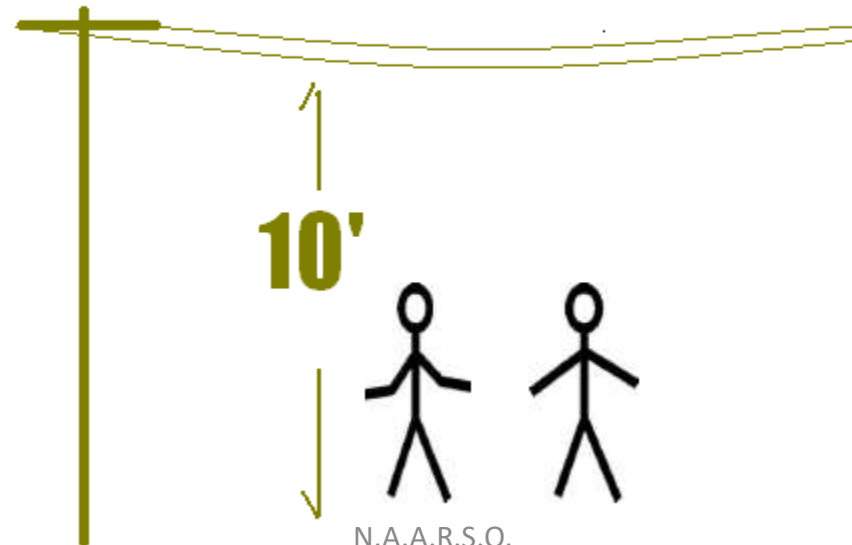

Overhead Conductor Clearances

Amusement rides or attractions shall not be located under or within 15' horizontally of conductors operating in excess of 600 volts

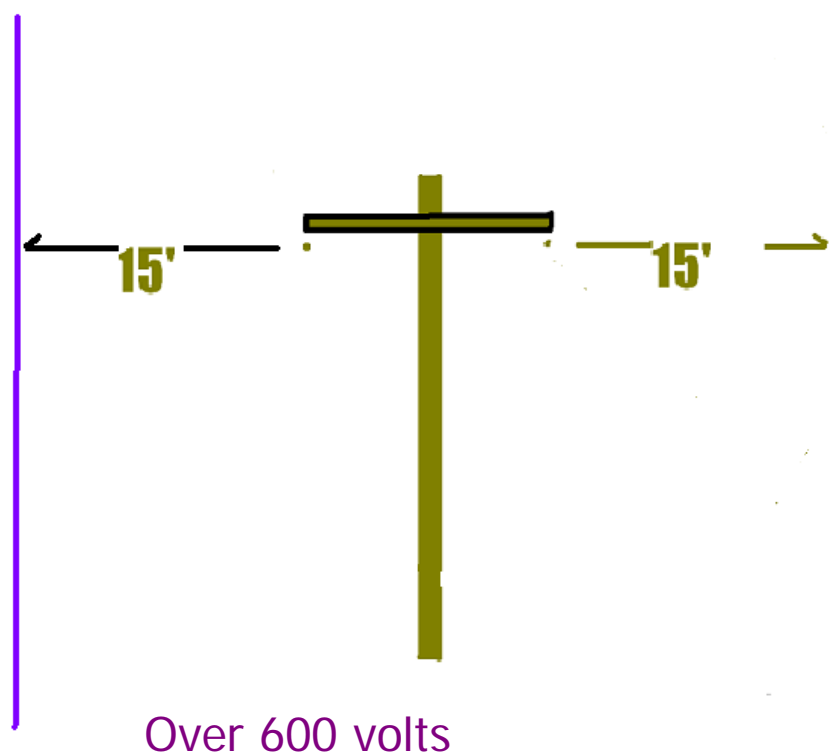

Overhead Conductor Clearances

- Overhead conductors must have a clearance of 15 ft from amusement rides and attractions (except, of course, for the conductors that supply power to the ride or attraction) [525.5(B)].

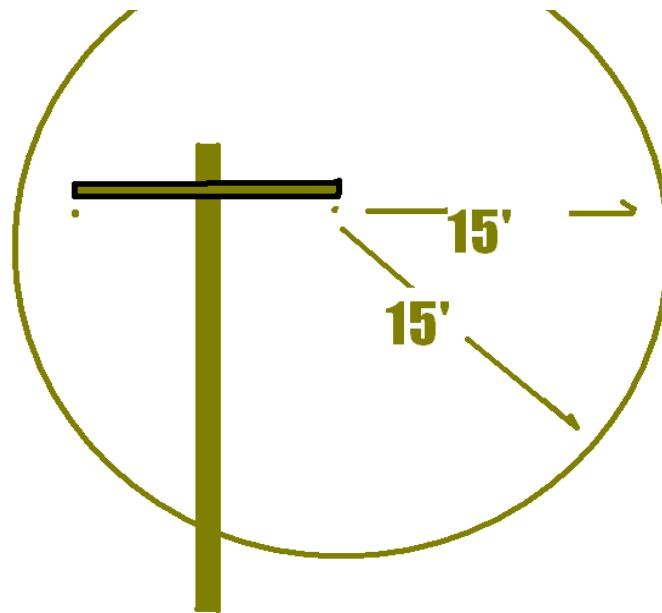

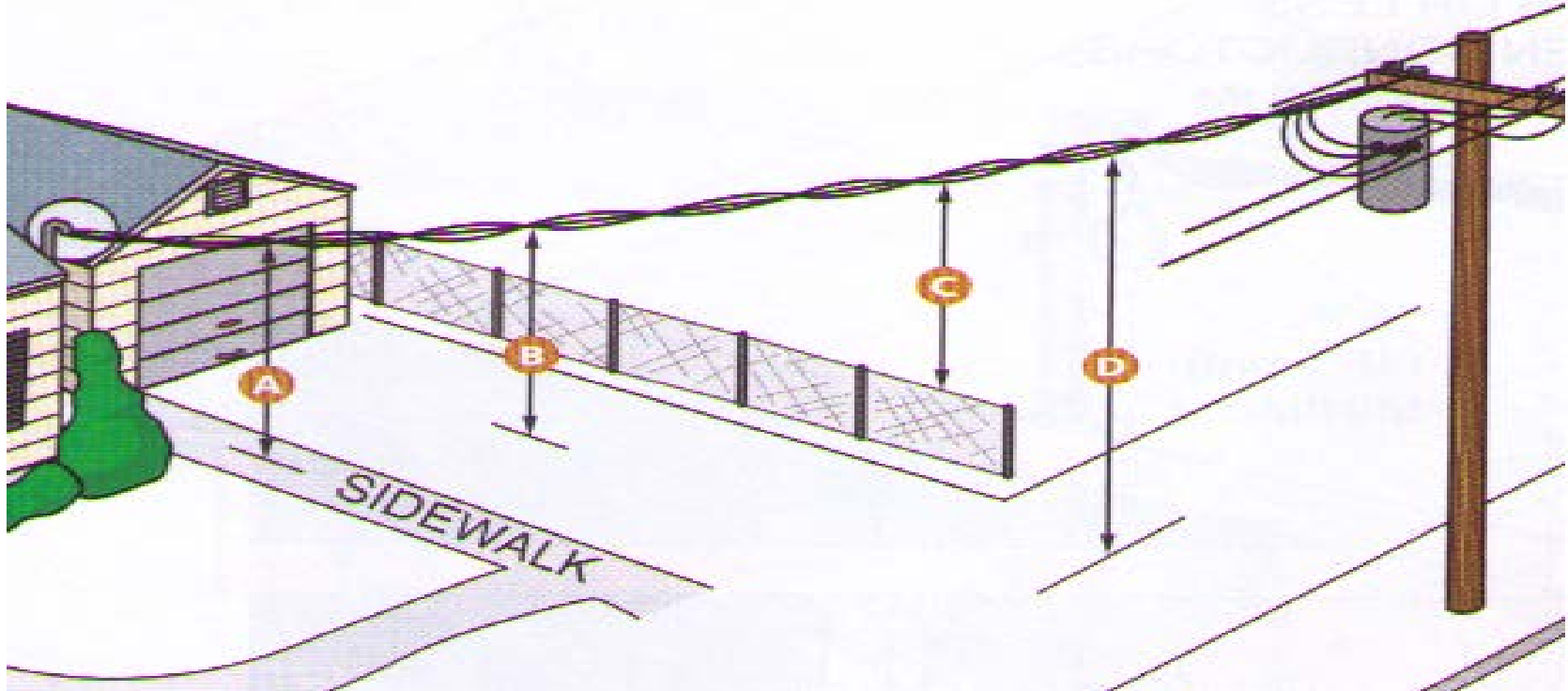

CLEARANCES FOR SERVICE
DROPS –
120/240 VOLT SINGLE PHASE:
A = 10 FT. (3.0 m) MINIMUM

B = 12 FT. (3.7 m) MINIMUM
C = 10 FT. (3.0 m) MINIMUM
D = 18 FT. (5.5 m) MINIMUM

445.13 **Generators.**

Generators or other power supply units and the associated electrical distribution cords and panelboards must be inspected at each engagement during the season.

Generators.

The conductors from the generator terminals to the first overcurrent device shall not be less than 115 percent of the nameplate rating of the generator.

To establish ground, the neutral terminal in the service equipment, transformer truck, or generator shall be connected to an approved grounding electrode system with a stranded copper grounding electrode conductor sized not smaller than 4 AWG.

This conductor shall be installed without splice from the grounding terminal to the grounding electrode shall be connected with approved clamps.

Signage on generators

Warning signs must be posted to indicate the danger of high voltage and to restrict access to qualified persons only.

The Generator

A fire extinguisher sized in accordance with the hazard shall be mounted, charged, tagged and readily accessible at the generator enclosure.

Class A - Wood, paper, cloth, trash, plastics

Solid combustible materials that are not metals.

Class B - Flammable liquids: gasoline, oil, grease, acetone

Any non-metal in a liquid state, on fire.

Class C - Electrical: energized electrical equipment

As long as it's "plugged in," it would be considered a class C fire.

Class D - Metals: potassium, sodium, aluminum, magnesium

Unless you work in a laboratory or in an industry that uses these materials, it is unlikely you'll have to deal with a Class D fire. It takes special extinguishing agents (Metal-X, foam) to fight such a fire.

CLASSES OF FIRES



CLASS A
(GREEN)



- ORDINARY COMBUSTIBLES



CLASS B
(RED)



- FLAMMABLE LIQUIDS AND GASES



CLASS C
(BLUE)



- ELECTRICAL EQUIPMENT



CLASS D
(YELLOW)



- COMBUSTIBLE METALS

EXTINGUISHER MARKINGS

ORDINARY



COMBUSTIBLES
(GREEN)



FLAMMABLE



LIQUIDS
(RED)



ELECTRICAL



EQUIPMENT
(BLUE)





A. Distribution and termination boxes shall be designed so that no live parts are exposed to accidental contact. Where used outdoors the boxes shall be of weatherproof construction (wooden distribution boxes prohibited) and mounted so that the bottom of the enclosure is not less than 6 in. above the ground. Such boxes shall be locked to prevent unauthorized opening Art 525-15(a) and fenced if located in public areas.

CAUTION

TURN OFF BREAKERS
BEFORE CONNECTING OR DISCONNECTING
PLUGS

CIRCUIT BREAKER
L101
L102
L103

ON 1 2 3 4 5 6 7 8 9 10 11 12 13 14 15 16 17 18 19 20 ON

OFF

OFF



First connect - Last disconnect

- Blue = hot
- Red = hot
- Black = hot
- White = neutral
- Green = ground

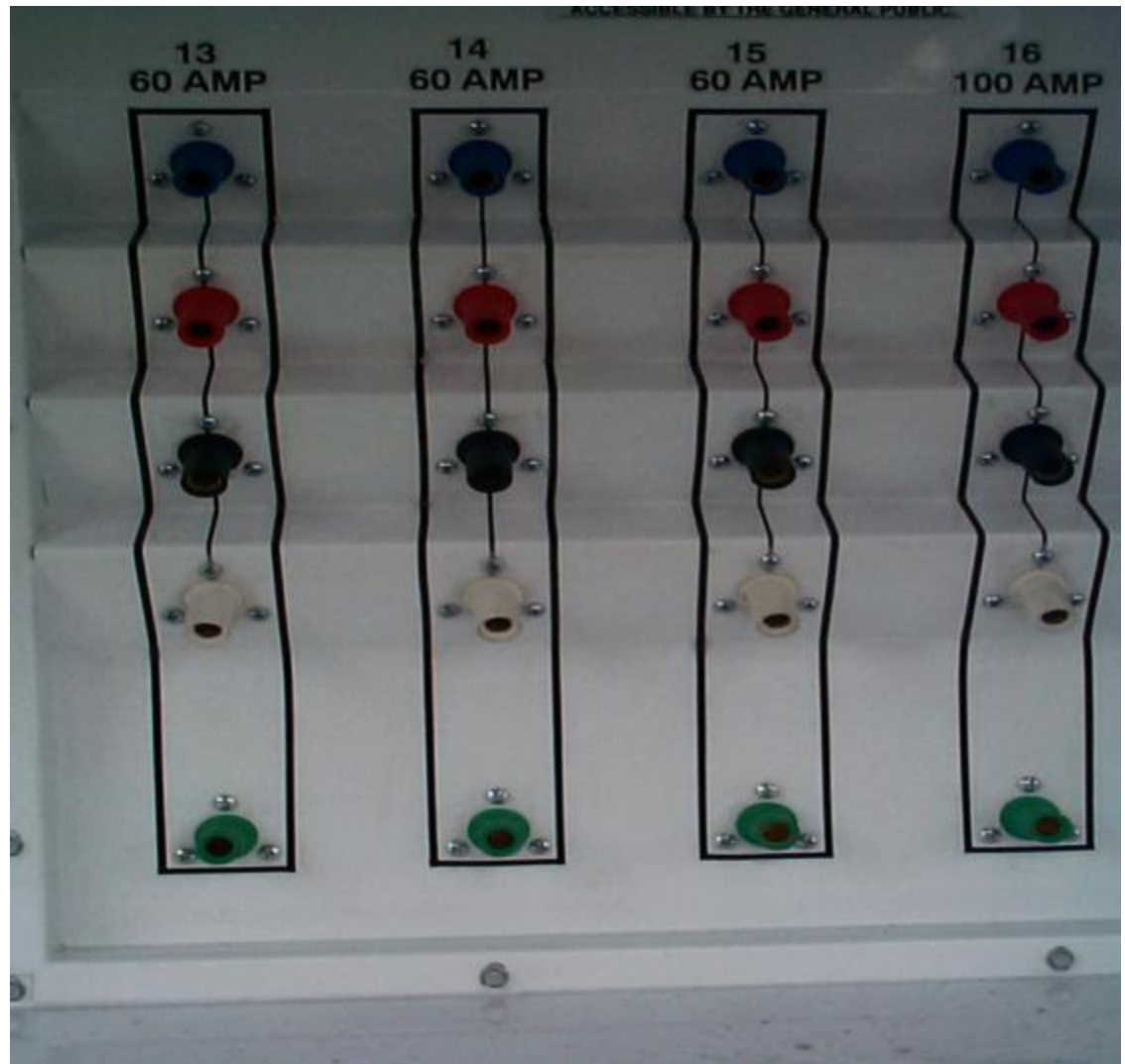

This diagram shows an example of an acceptable disconnecting switch for a typical concession unit.

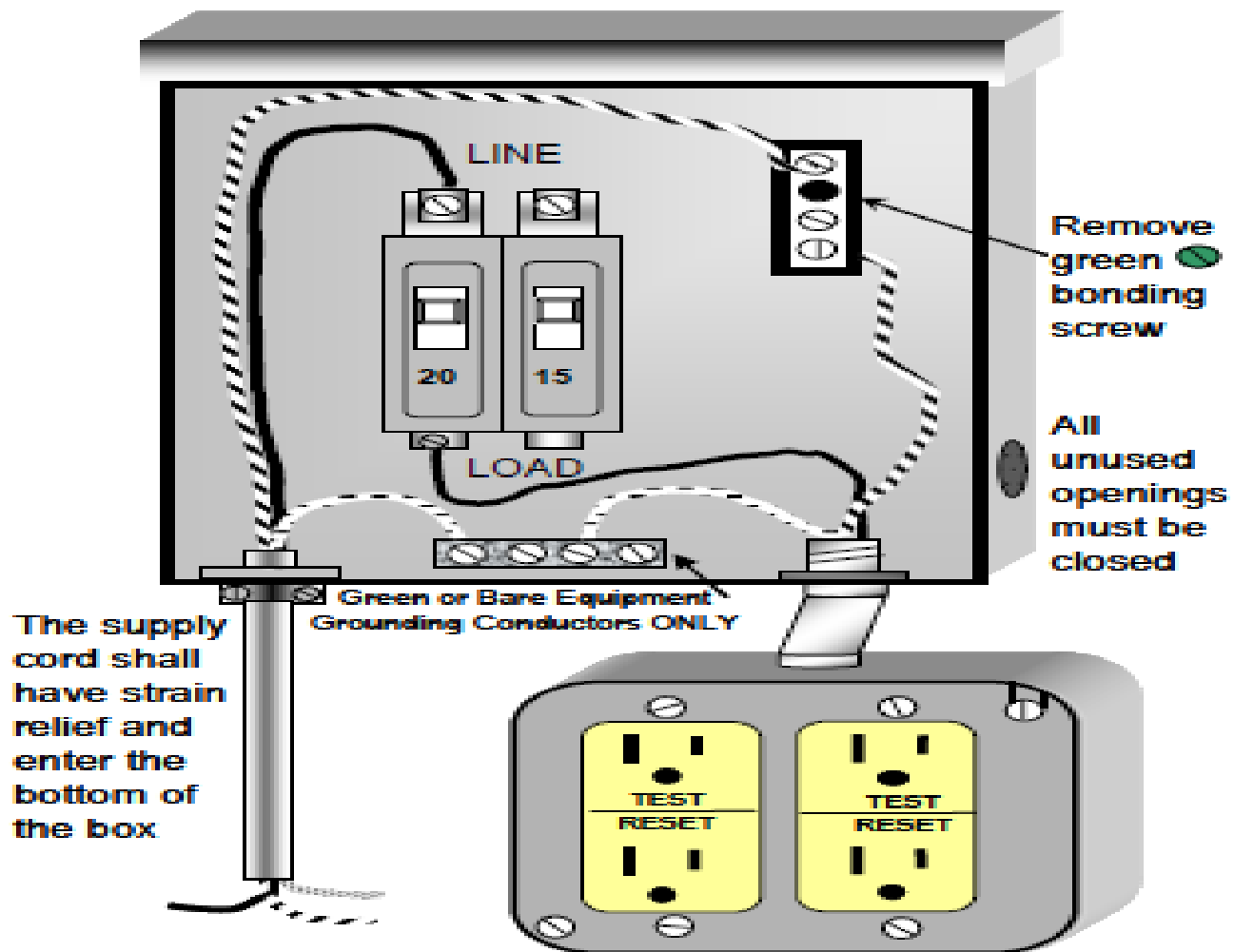

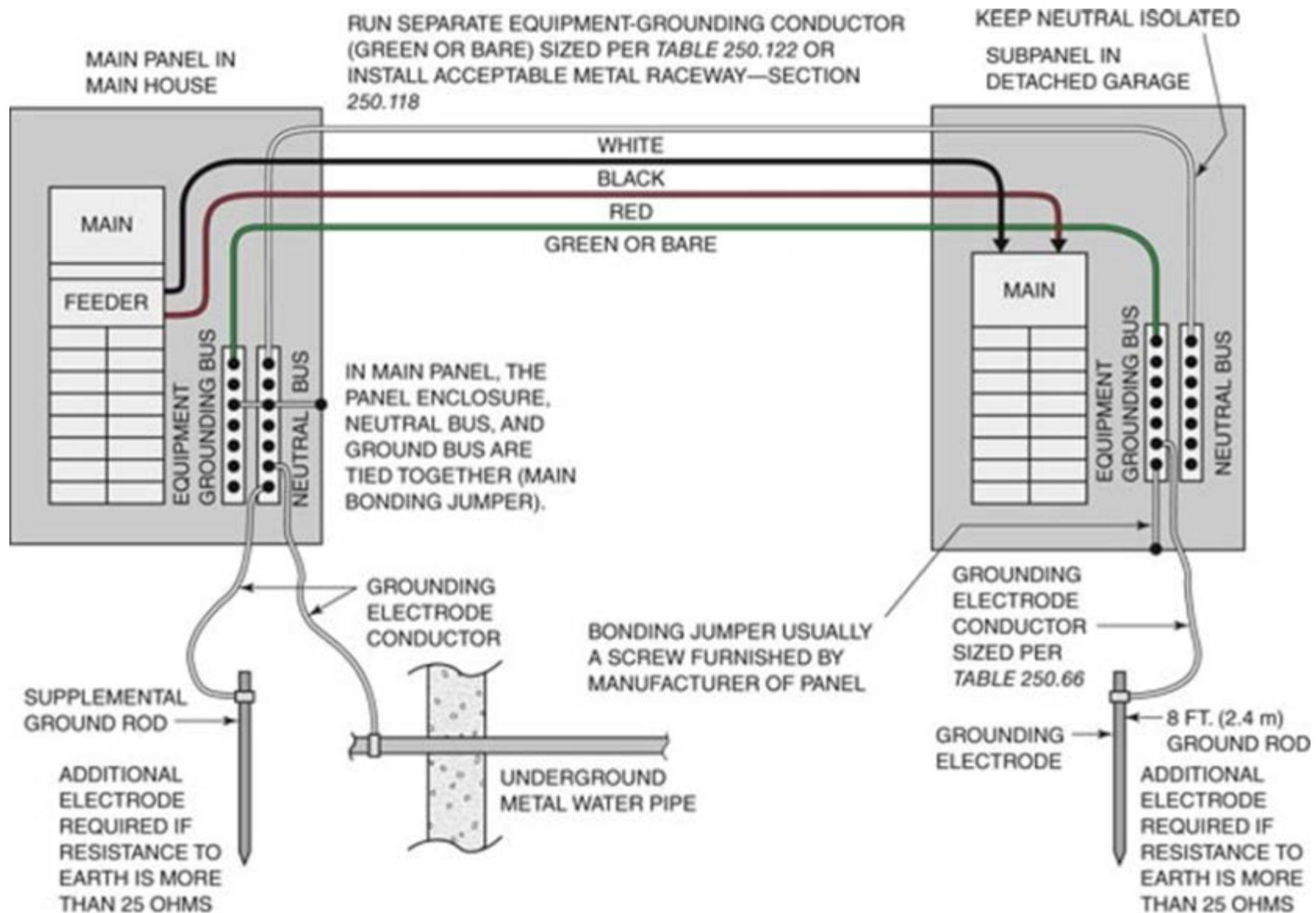

Electrical Service Grounding

- Grounding Electrode (two)
- Continuous, no splices, meter bypass
- Copper ground wires and grounding conductor (corrosion resistant)
- Aluminum - insulated solid conductor
- Aluminum - insulated multi-strand
- Aluminum - bare vs. insulated (risk of corrosion, break in wire, loss of safe grounding)

GROUND RODS and PIPES

- Rods and pipes shall not be less than 8ft. In length.
- Non-ferrous rods shall be listed and shall not be less than ½” in diameter; 5/8” for iron or steel rods and ¾” for iron or steel pipe or conduit.
- Rods and pipes must have at least 8’ of their length in contact with the soil. Driven in at an angle not greater than 45 degrees or buried in a trench not less than 2 ½ ft. deep.
- The upper end of the electrode and electrode attachment shall be flush with the ground unless protected from damage.

(Art 250-52 (c) (3) and (d))

Table of Electrical Ground Wire Sizes

- Ground Gauge CU (Copper) Service Size
 - #8 to 100A
 - #6 to 125A
 - #4 to 165A
 - #3 to 200A

GROUNDING ELECTRODE
CONDUCTORS

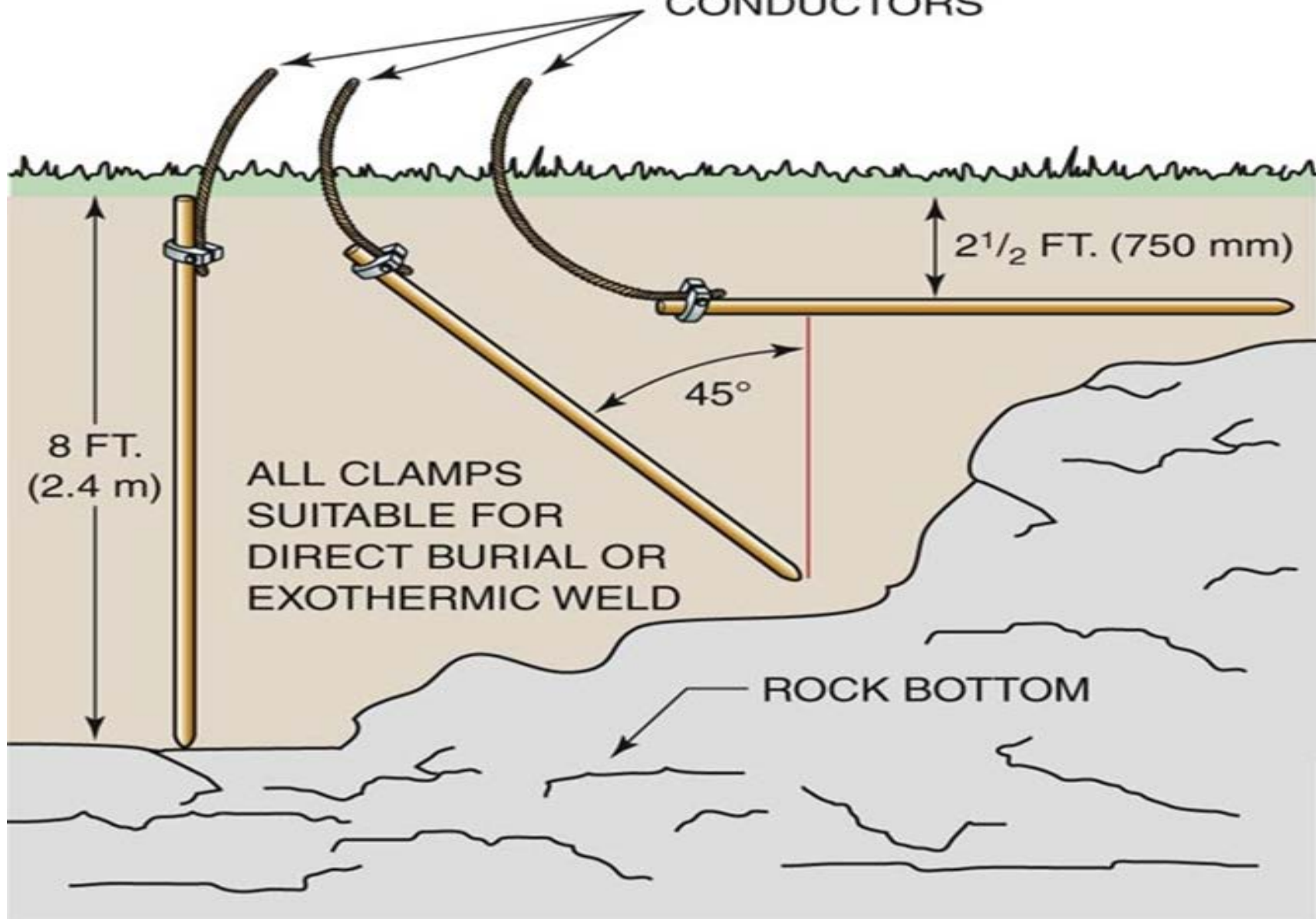



CLAMPS SUITABLE
FOR DIRECT BURIAL

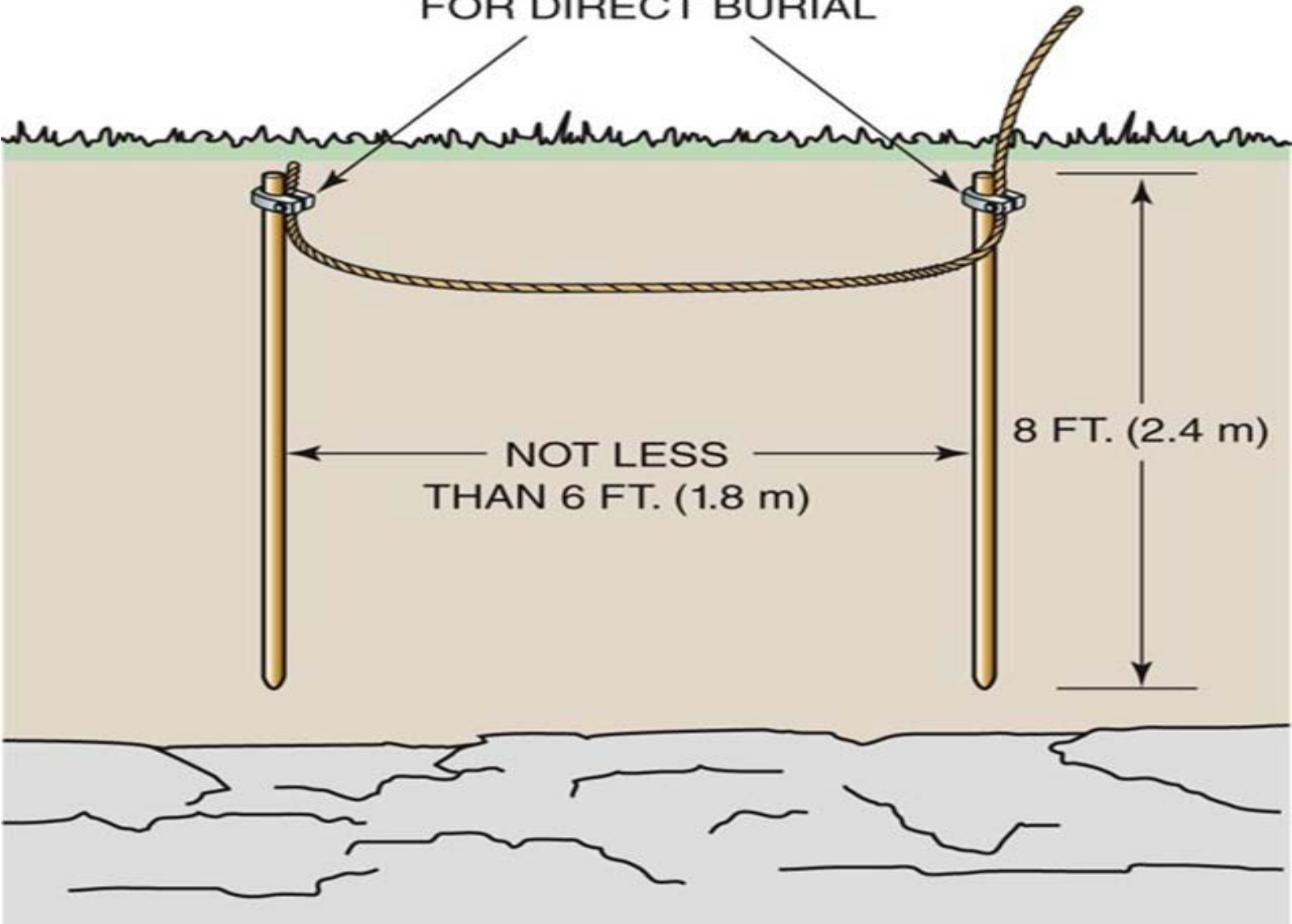





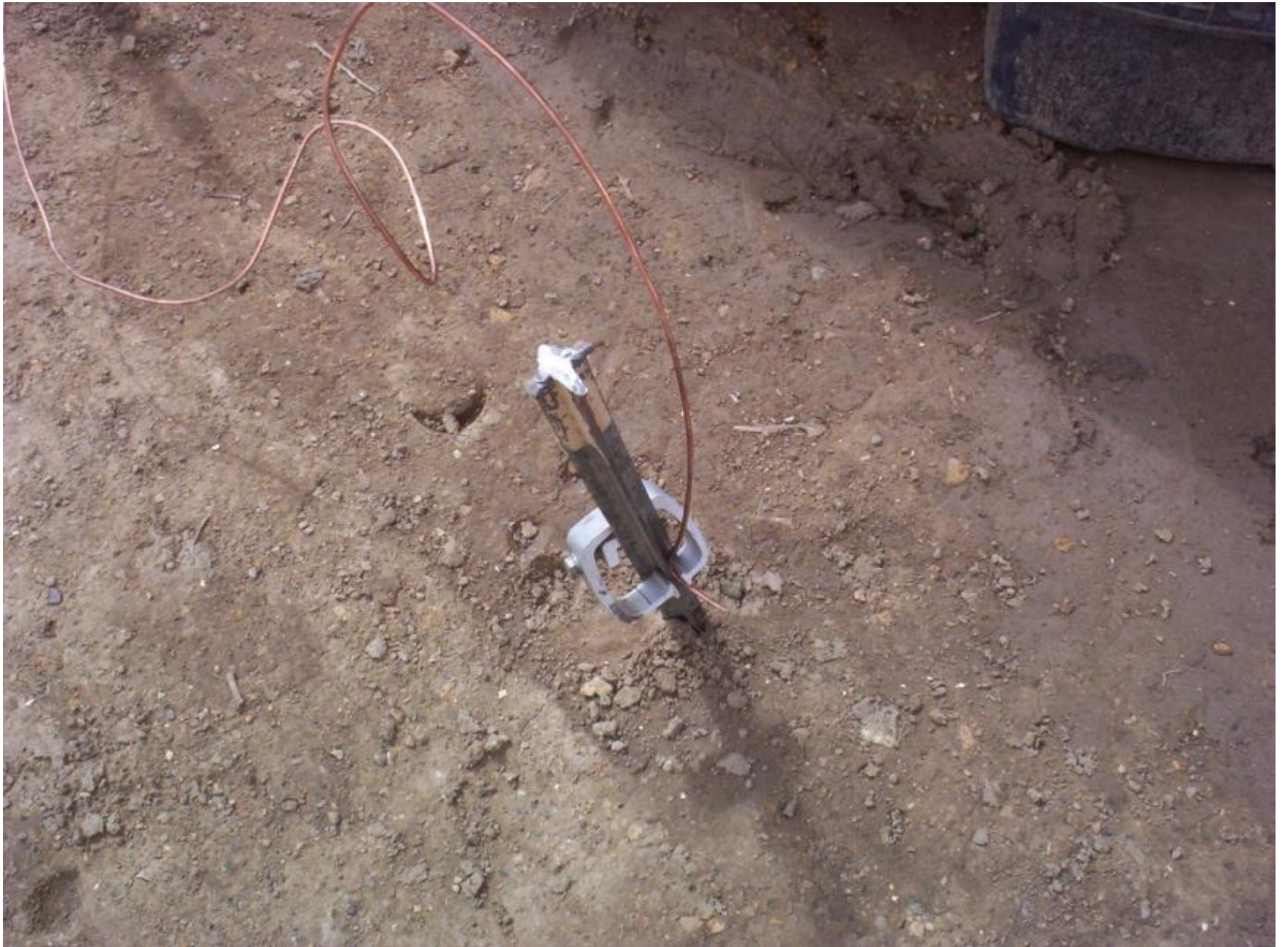







BALDOR
GENERATORS

TS25

BAL
GENER



P0509150007

P0509150007

PLATE ELECTRODES

- In lieu of rods and pipes for grounding electrodes, plate electrodes may be used provided they are not less than 2 square feet of surface area in size and at least on quarter inch thick.
- Plate electrodes shall be buried not less than 2 and ½ feet below the surface.

Art. 250-52 (d)

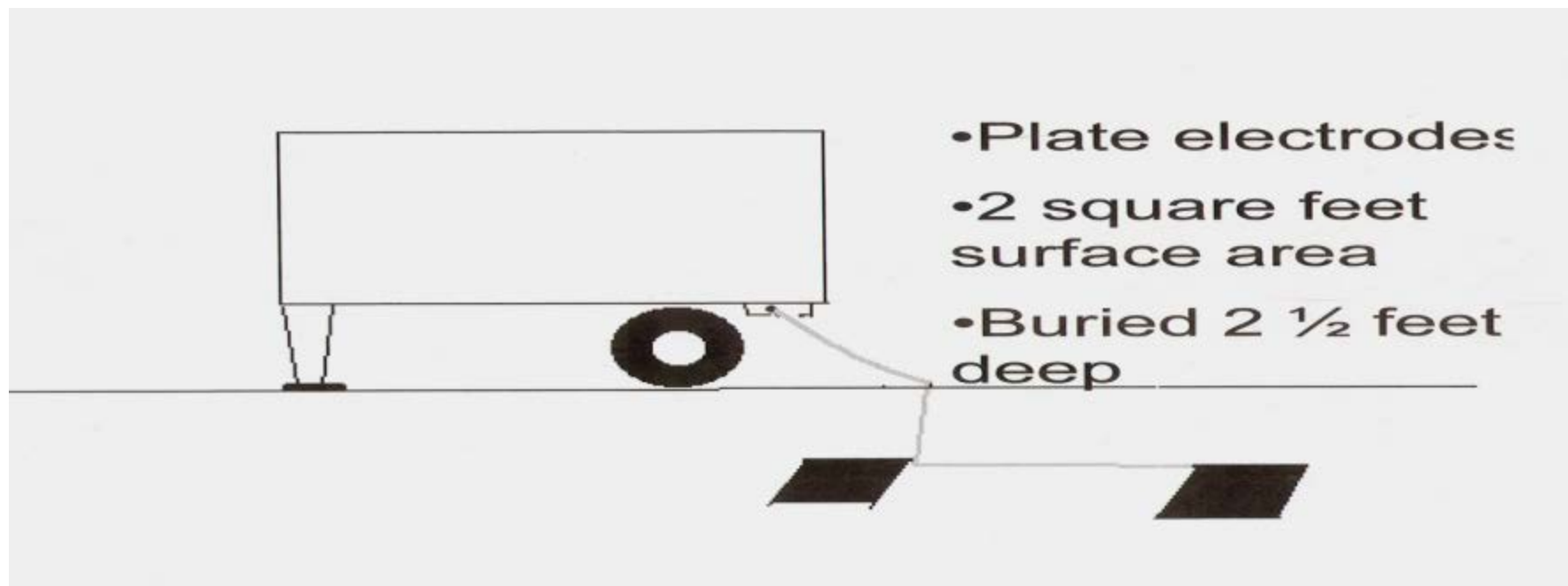

Resistance of Rod, Pipe, and Plate Electrodes

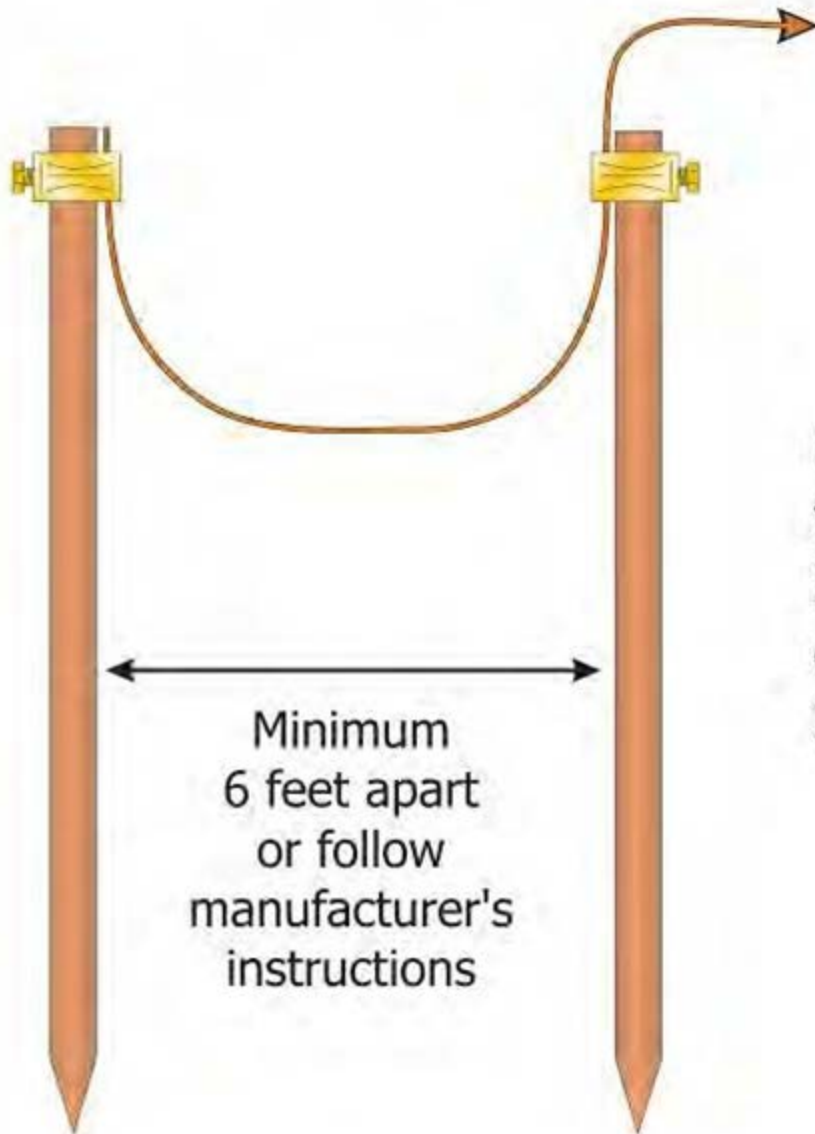

Minimum
6 feet apart
or follow
manufacturer's
instructions

Rod, pipe, or plate electrode that exceeds 25 ohms must be augmented by an additional electrode of a type specified in 250.52(A)(4) through (A)(8)

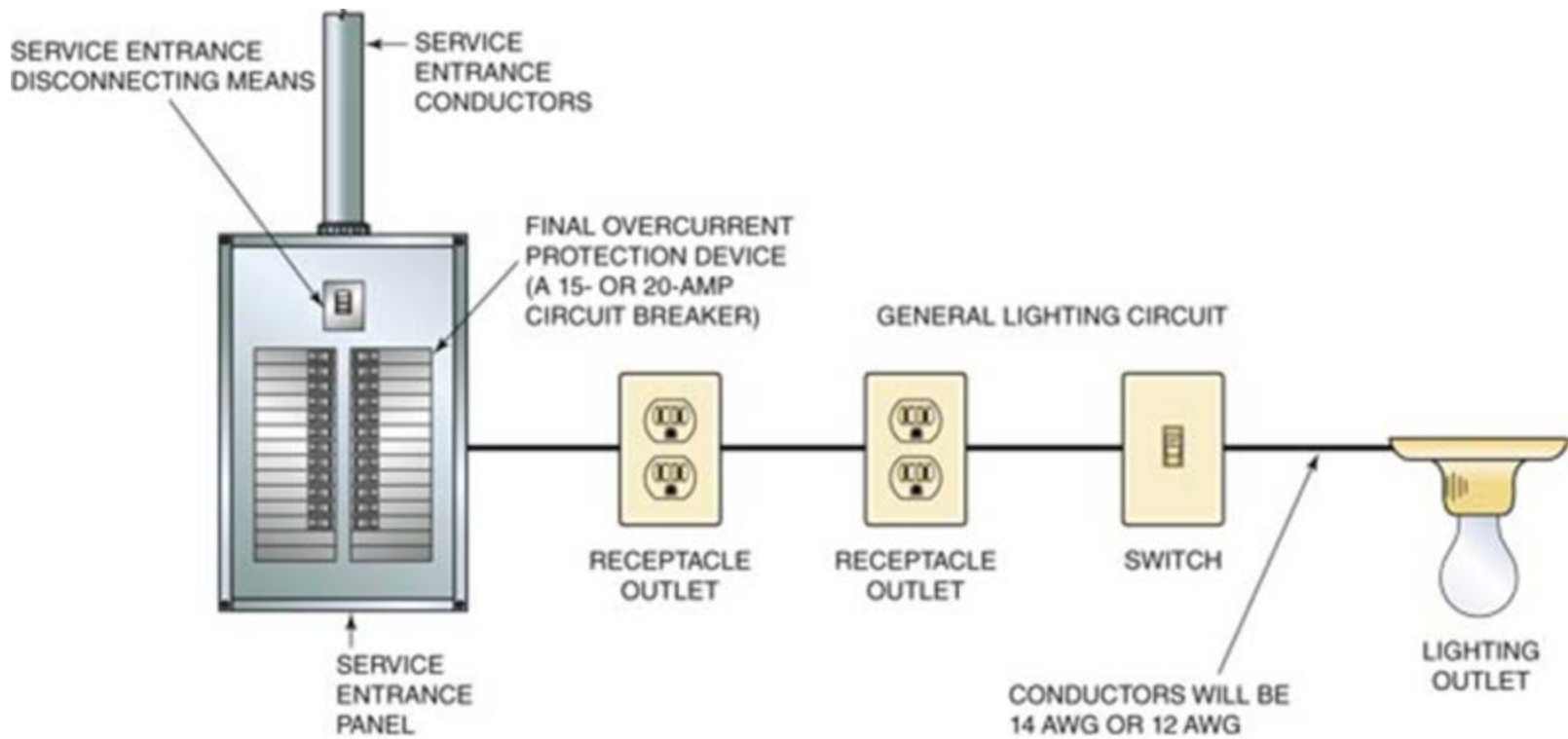

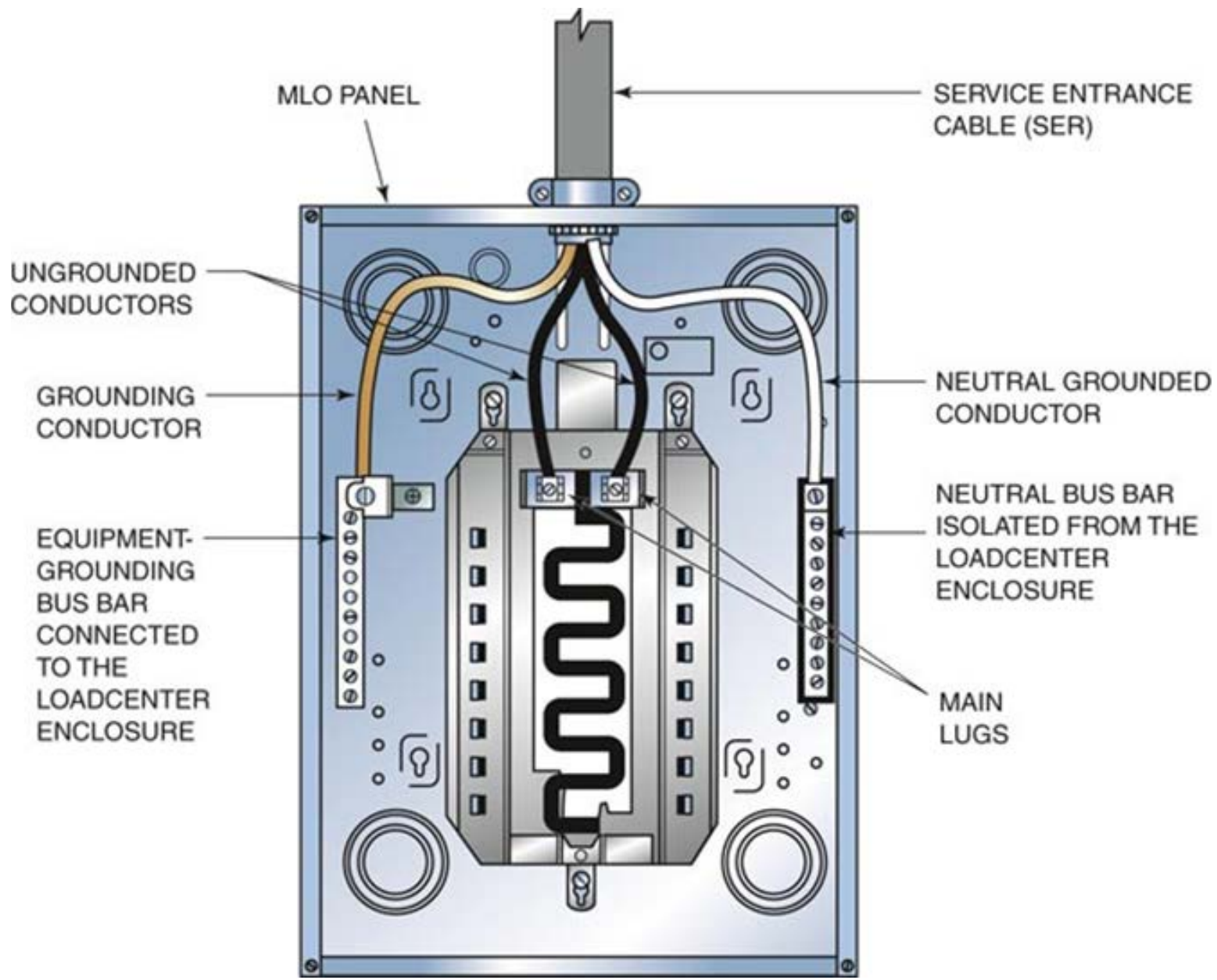





SQUARE D
ENCLOSED
CIRCUIT BREAKER

AUTOMATIC TRIP IS INDICATED BY HANDLE POSITION. TO RESET, MOVE HANDLE TO "ON" POSITION. TO TRIP, MOVE HANDLE TO "OFF" POSITION.

▲ DANGER
SHOCK HAZARD
LIVE PARTS
INSIDE

WARNING: This equipment is designed for use in hazardous locations. It is not to be used in non-hazardous locations. For information on hazardous locations, see the National Electrical Code, NFPA 70, and the manufacturer's literature. For information on hazardous locations, see the National Electrical Code, NFPA 70, and the manufacturer's literature.



WARNING
▲ This equipment is designed for use in hazardous locations. It is not to be used in non-hazardous locations. For information on hazardous locations, see the National Electrical Code, NFPA 70, and the manufacturer's literature. For information on hazardous locations, see the National Electrical Code, NFPA 70, and the manufacturer's literature.













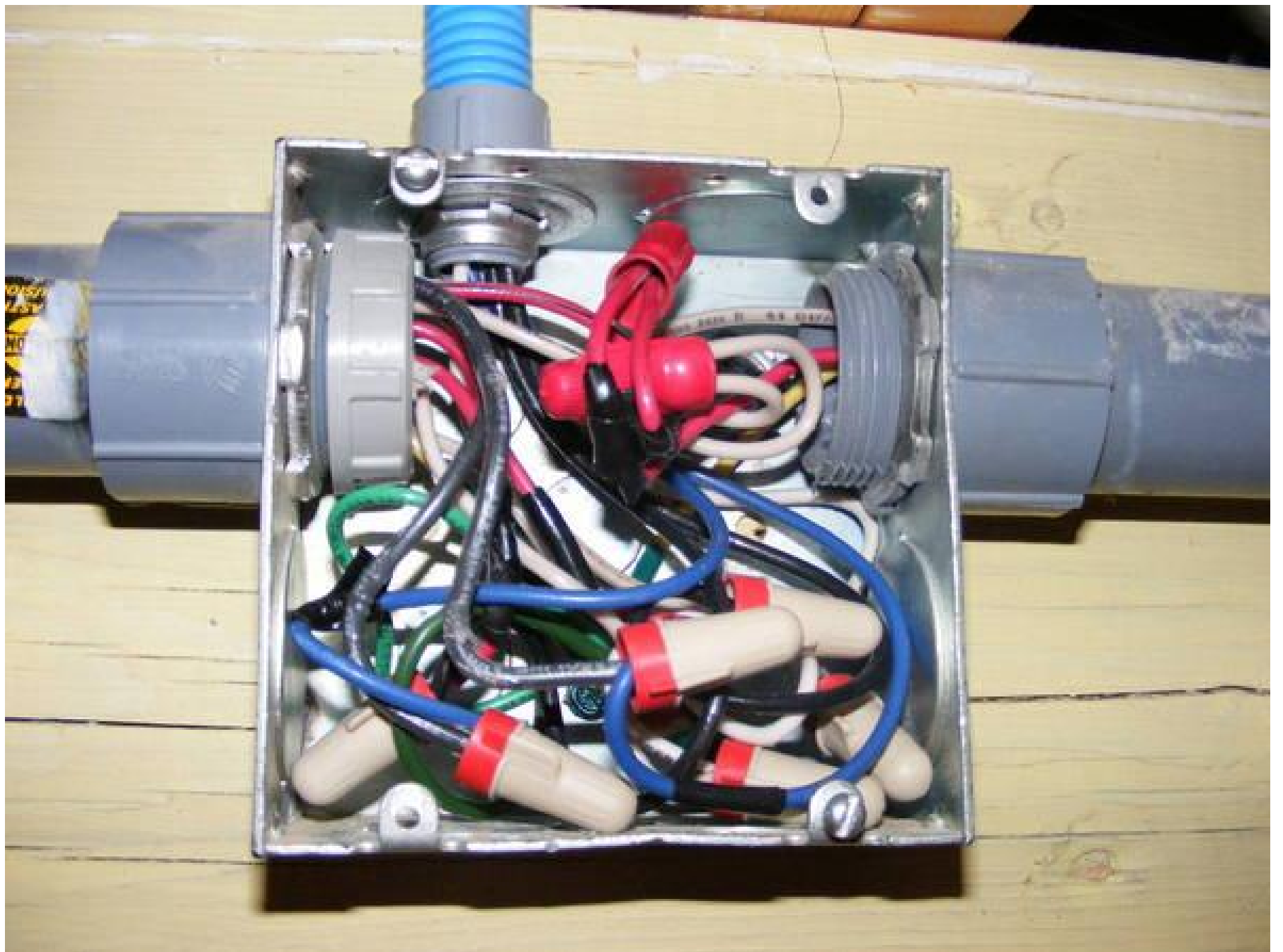





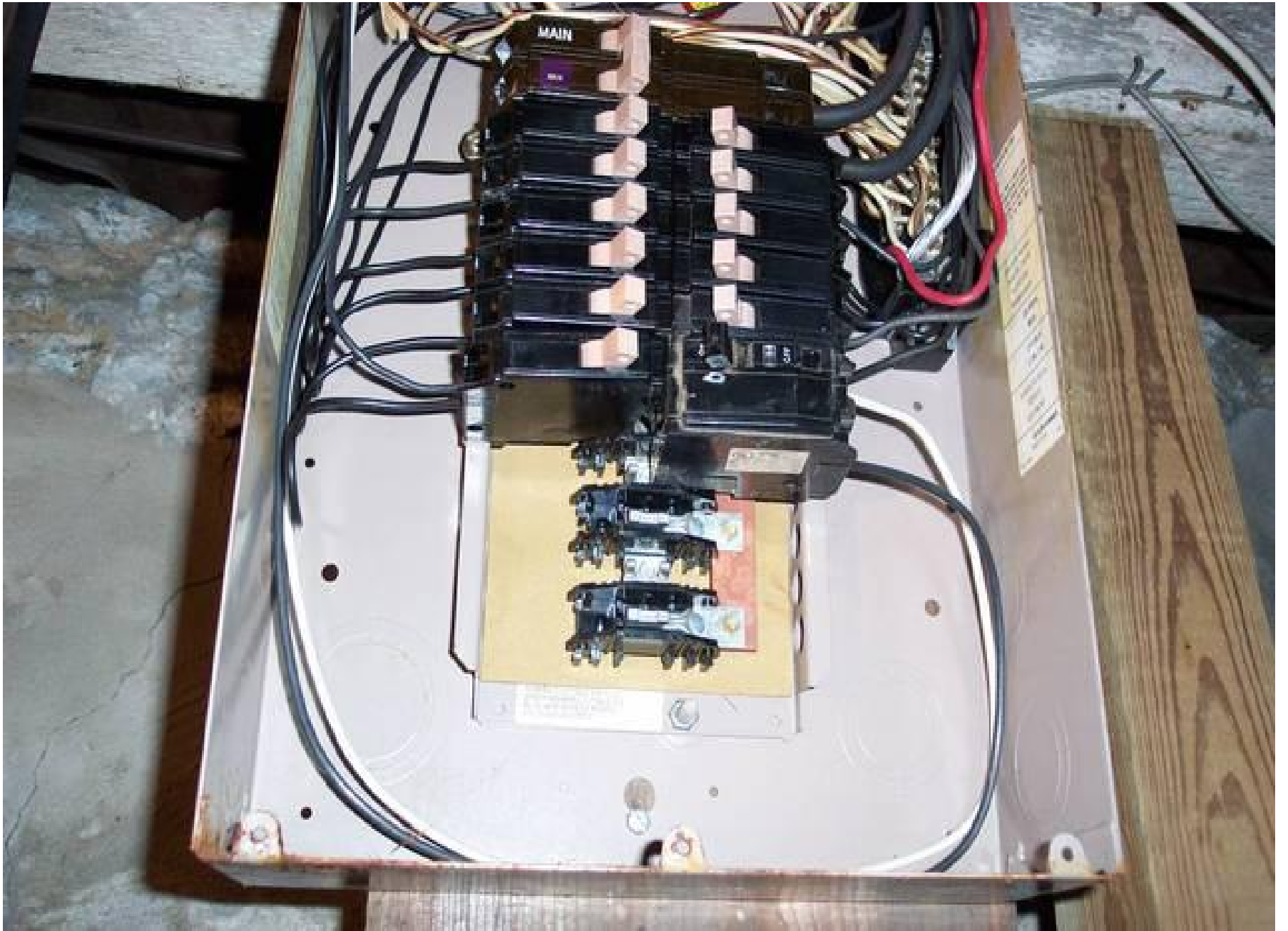



Wood distribution box

Not weather resistant

Not 6" off the ground



Open bus bars & no overcurrent protection



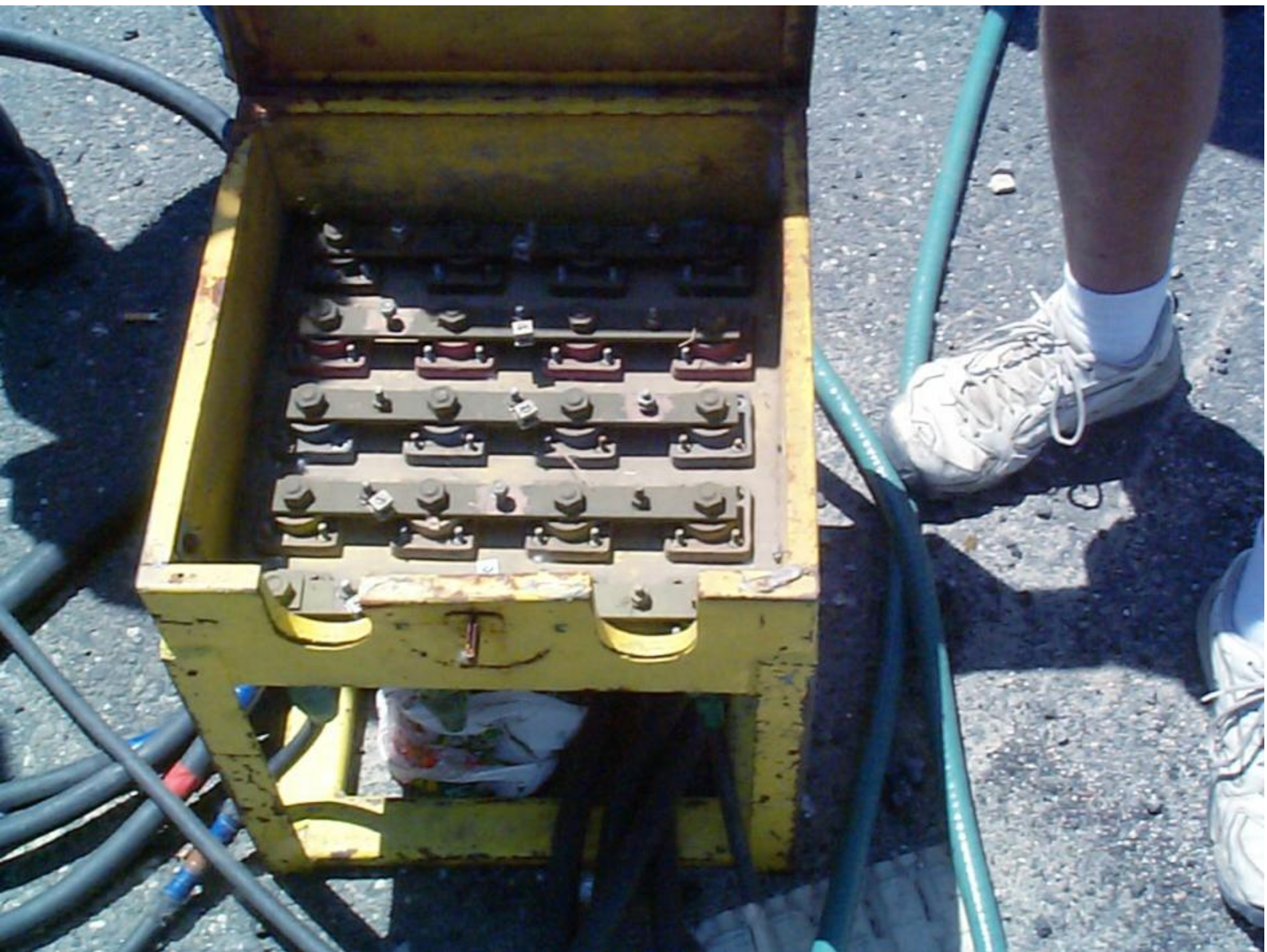



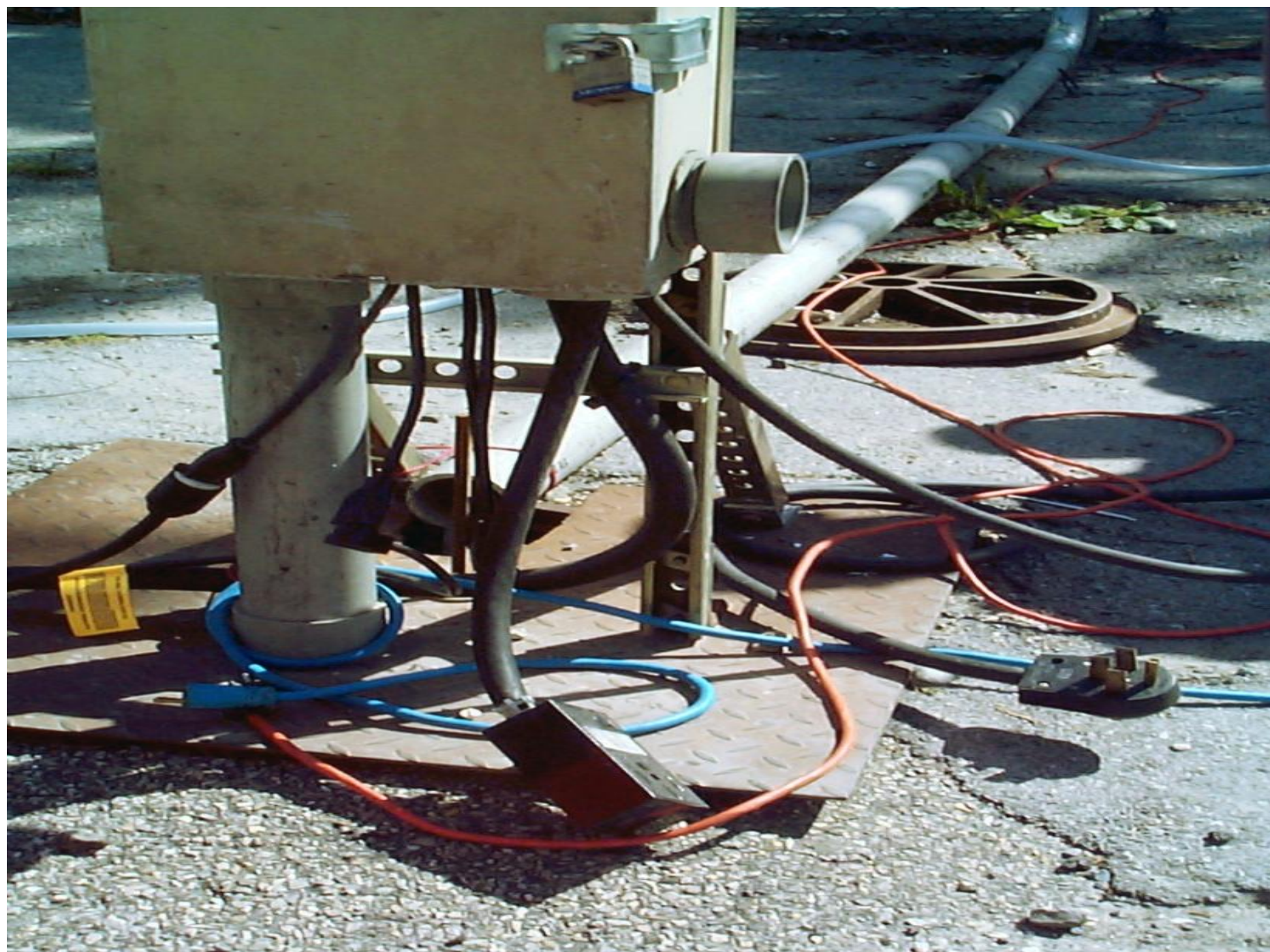

• Proper matting on midway



